

CP-200HT-TT Peltier-Thermoelectric Cold-Plate Cooler

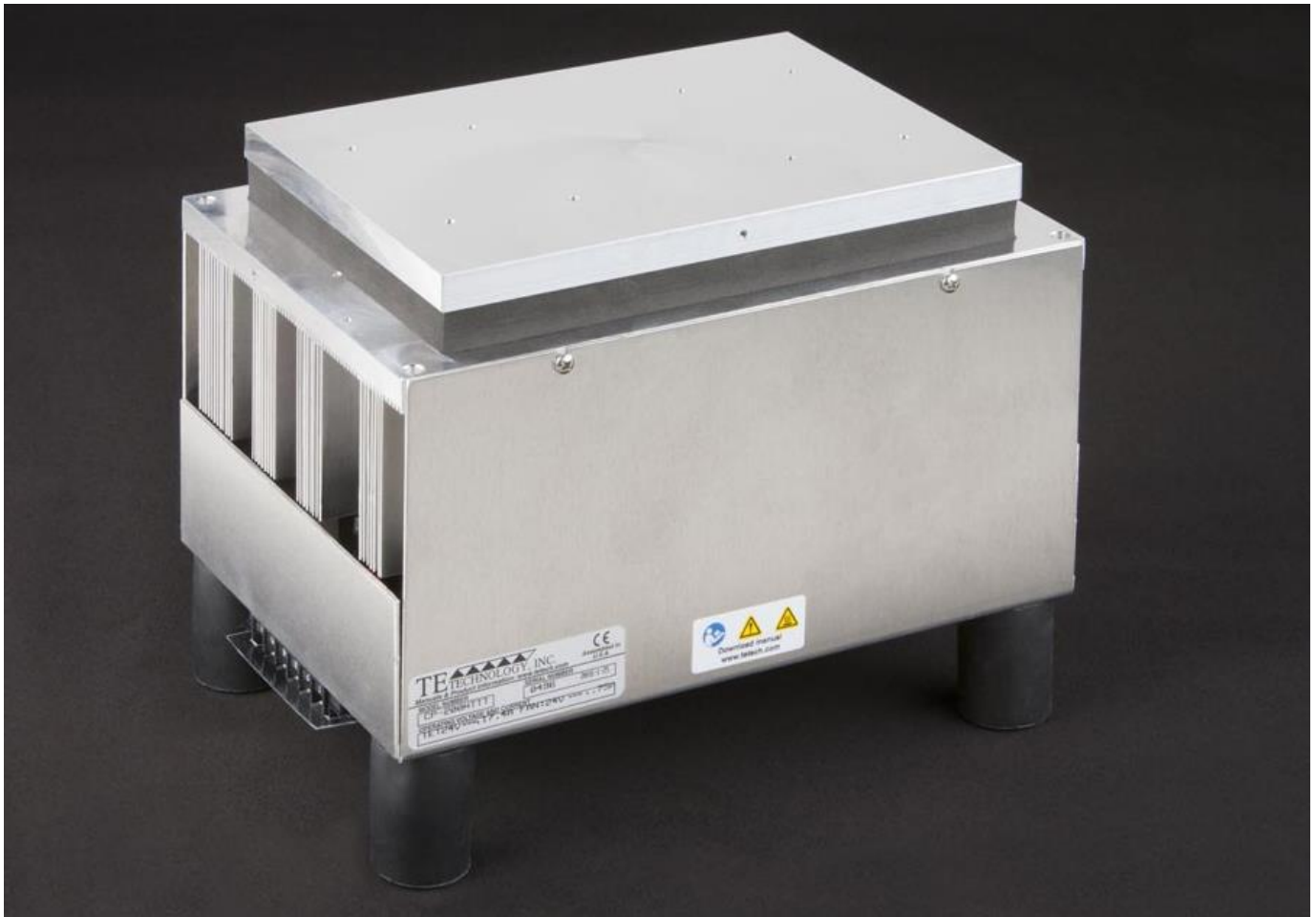

- Heats as well as cools (when used with heat & cool / bipolar controller).
- Table Top (TT) version has legs added bench top and standalone use.
- High Temperature (HT) Series can heat to 100°C.
- Useful for large heat loads.
- Stainless steel liquid heat exchanger (LC-SSX1) can be attached for cooling corrosive liquids.
- Provides effective direct-contact cooling which is ideal for precision temperature control.
- Efficient bonded-fin heat sink keeps cooler small but effective.
- Threaded holes are located in the cold plate for easy attachment of a temperature sensor, interface plates, and other cooled plates.
- High-temperature version and other customizations are available upon request.
- CE marked, RoHS compliant.

TE  **TECHNOLOGY, INC.**[®]

Expert Engineering, Precision Manufacturing:
Quality Thermal Solutions Delivered

<https://tetech.com/> • cool@tetech.com • 231-929-3966 • 1590 Keane Drive • Traverse City, MI 49696

CP-200HT-TT Specifications

Thermoelectric (TE) Power (typical)^{1,3}: 24 VDC at 14.1 A
 Thermoelectric (TE) Power (maximum)^{2,3}: 24 VDC at 17.9 A
 External (ambient) Fan Power: 24 VDC at 1.0 A
 External (ambient) Fan Noise: 55 dBA

NEMA Rating: NA
 Weight (kg): 6.7

⚠ Please review the [Thermoelectric Cooling Assembly \(TCA\) Instruction Manual](#) (or [manual in other languages](#)), [ordering information](#), and [FAQ's](#) for related technical information before purchasing or using this product.

Performance is based on unrestricted air flow to fans and from air-flow outlets. Do not operate if the heat sink or cold plate exceeds 100 °C. Do not operate fan at air temperatures below -10 °C or over 70 °C.

¹Current, at steady-state, is rated at +25 °C ambient, +25 °C internal, maximum heat removal. At -25 °C internal, the typical steady-state current is 13.6 A.

²Current, at steady-state operation is rated at -10 °C ambient, +70 °C internal, maximum heat removal.

³Total current consumption is sum of TE current and Fan current.

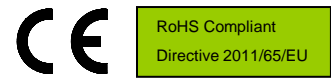
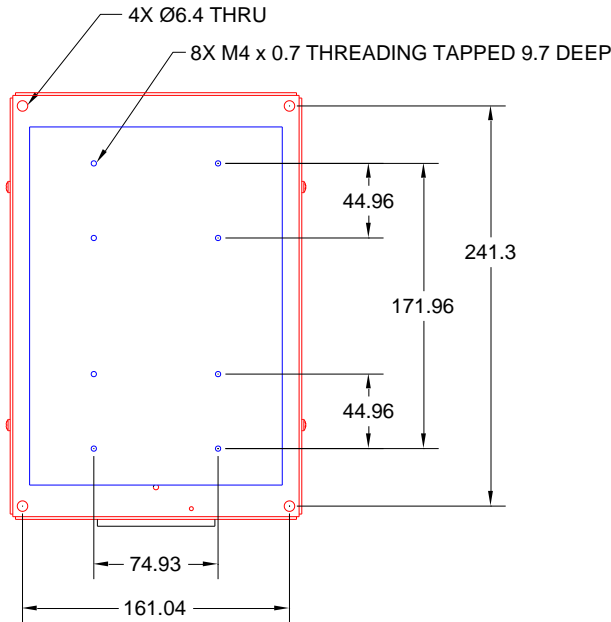

A 3D PDF, .stp, and .x_t solid models are also available from the website.

All dimensions in millimeters.
 Cold plate shown in blue;
 External (ambient) side shown in red.

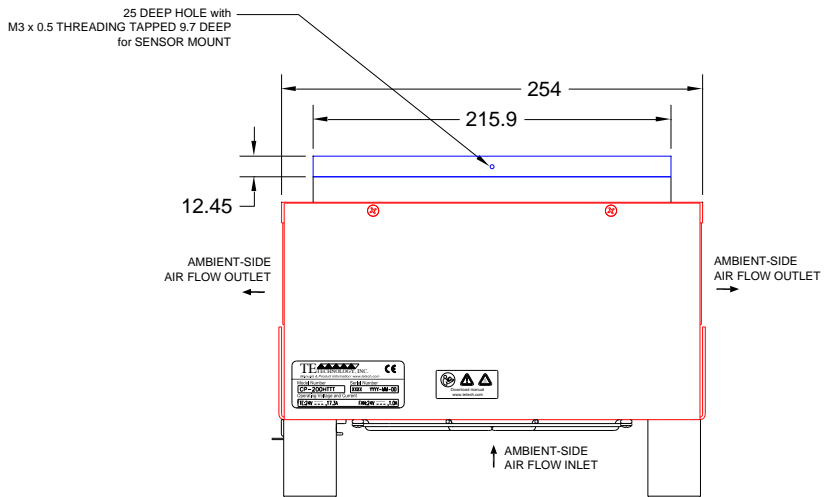
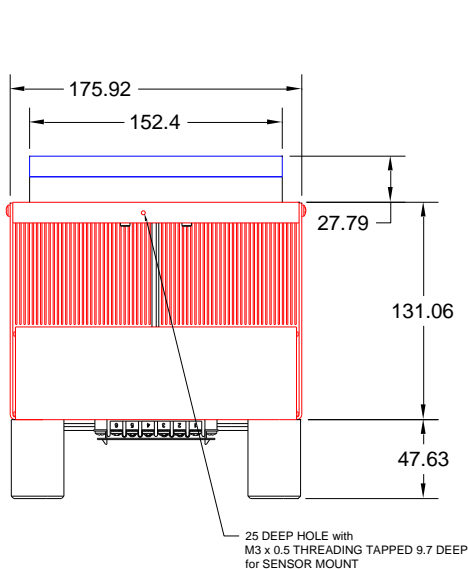

Expert Engineering, Precision Manufacturing:
 Quality Thermal Solutions Delivered

<https://tetech.com/> • cool@tetech.com • 231-929-3966 • 1590 Keane Drive • Traverse City, MI 49696

CP-200HT-TT Cooling Performance Graph

(removing heat from cold plate)

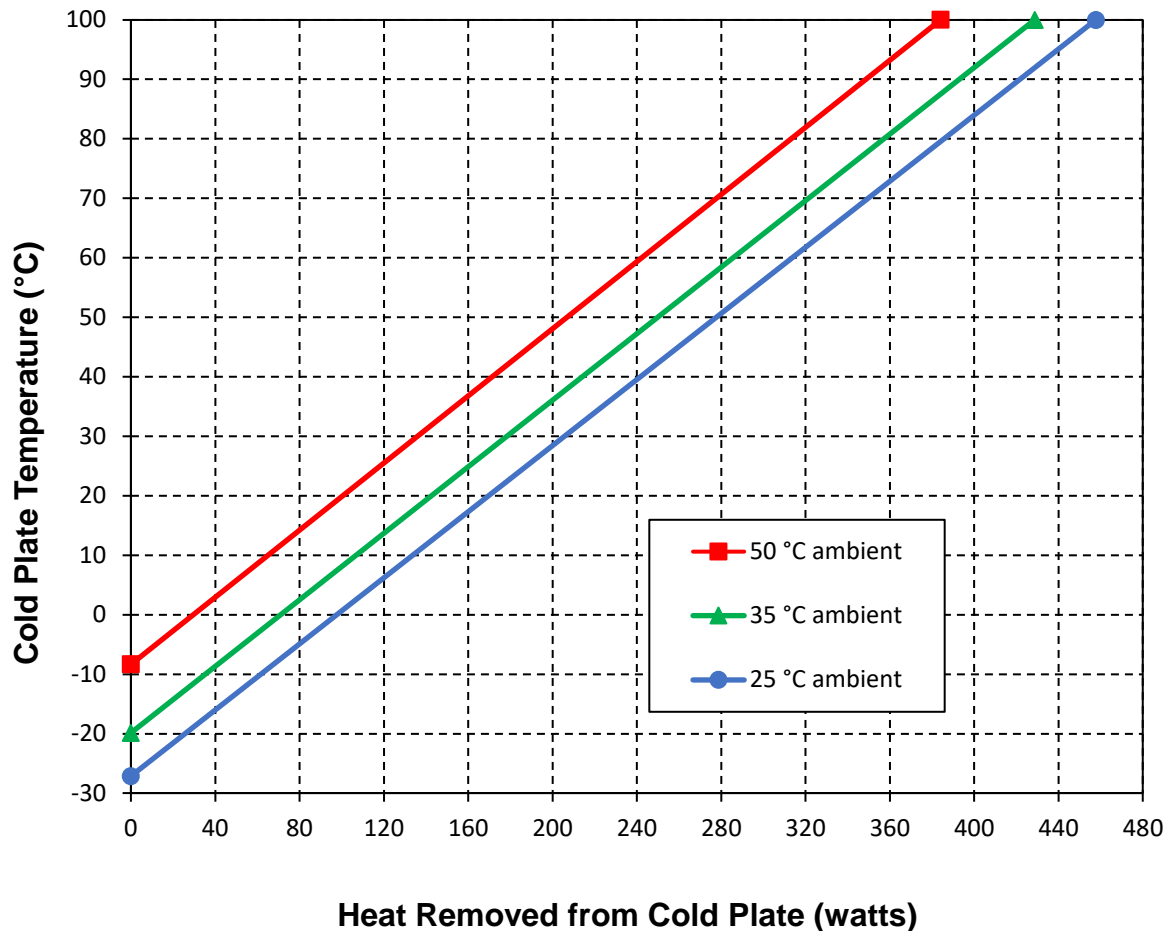

How to use the Performance Graph:

1. Select Performance Line

The diagonal lines represent cooling performance at the indicated ambient air temperature (intake temperature on the ambient-side fan). If the cooler is to operate at a different ambient, then you must sketch in a new performance line. This can be drawn parallel to one of the existing lines, using the distance between the existing lines as a scale to properly locate the new line.

2. Select Enclosure Temperature

Draw a horizontal line on the graph corresponding to the desired cold-plate temperature. Make the line intersect with the performance line corresponding to the ambient temperature at which the cooler is to operate.

3. Determine Cooling Capacity

The maximum amount of heat that the cooler can remove from the cold plate is determined by the intersection point (determined in the previous step). *The cooler will be able to maintain the desired temperature if the cooling capacity exceeds the heat load. If the heat load exceeds the cooling capacity then a higher capacity cooler will be needed.*

Example: You need to maintain the cold plate at 10 °C while in a 25 °C ambient. The cooler can remove a maximum of approximately 140 W of heat from the cold plate. If the heat gain from the ambient plus anything else actively generating heat exceeds this, you would need a cooler with a larger cooling capacity or multiple coolers.

TE TECHNOLOGY, INC.®

Expert Engineering, Precision Manufacturing:
Quality Thermal Solutions Delivered

<https://tetech.com/> • cool@tetech.com • 231-929-3966 • 1590 Keane Drive • Traverse City, MI 49696

CP-200HT-TT Heating Performance Graph

(adding heat to cold plate)

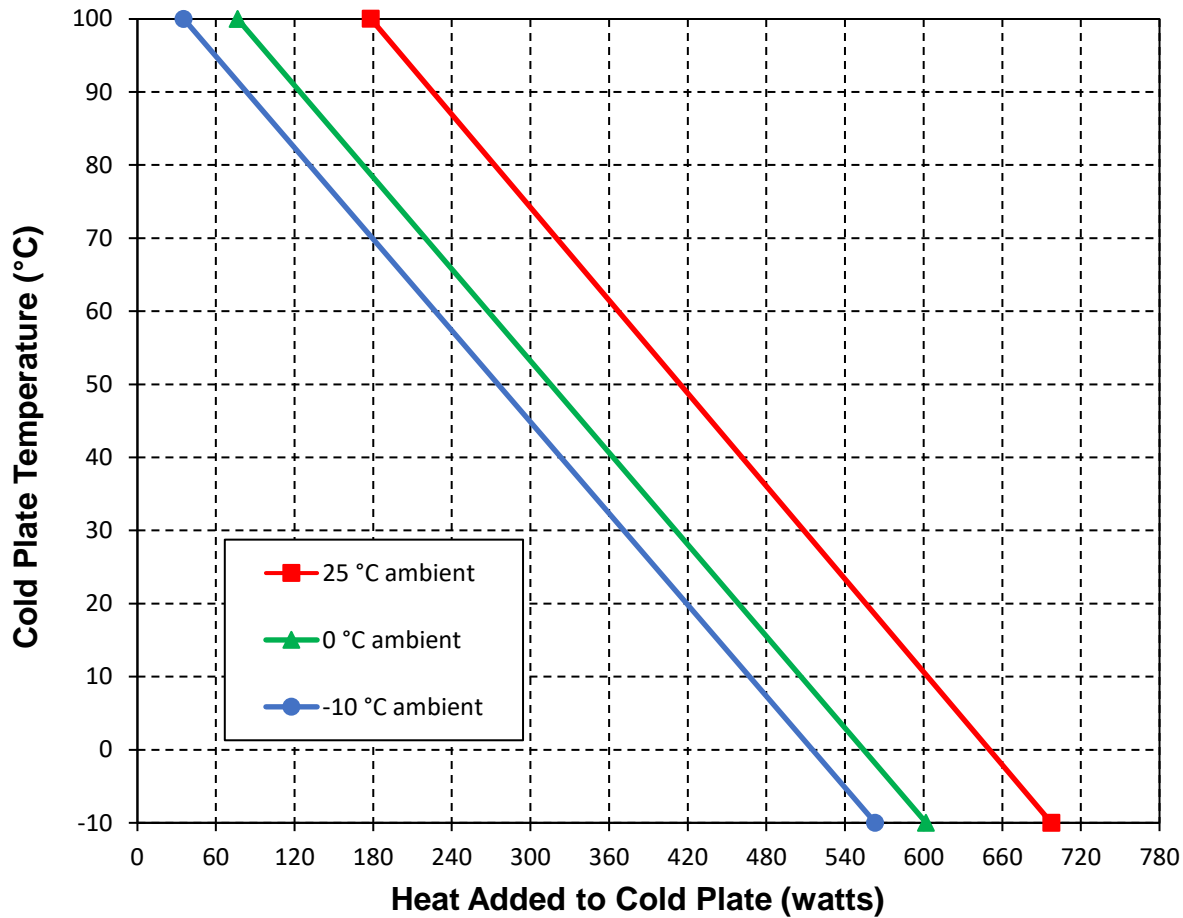

How to use the Performance Graph:

1. Select Performance Line

The diagonal lines represent heating performance at the indicated ambient air temperature (intake temperature on the ambient-side fan). If the cooler is to operate at a different ambient, then you must sketch in a new performance line. This can be drawn parallel to one of the existing lines, using the distance between the existing lines as a scale to properly locate the new line.

2. Select Enclosure Temperature

Draw a horizontal line on the graph corresponding to the desired cold-plate temperature. Make the line intersect with the performance line corresponding to the ambient temperature at which the cooler is to operate.

3. Determine Heating Capacity

The maximum amount of heat that the cooler can add to the cold plate is determined by the intersection point (determined in the previous step). *If the heat added to the cold plate (including heat generated by equipment on the cold plate) is greater than the heat loss from the cold plate, then the cooler will be able to heat to the desired temperature.*

Example: You need to maintain the cold plate at 25 °C while in a 0 °C ambient. The cooler can add up to approximately 435 W of heat to the cold plate. If the heat dissipation from the cold plate to the ambient exceeds this (plus anything else generating heat), you would need multiple coolers or a cooler with a larger heating capacity.



Expert Engineering, Precision Manufacturing:
Quality Thermal Solutions Delivered

<https://tetech.com/> • cool@tetech.com • 231-929-3966 • 1590 Keane Drive • Traverse City, MI 49696

Terminal Block Configuration for Continuous Operation at Full Power

As-Shipped Configuration 1 of 2

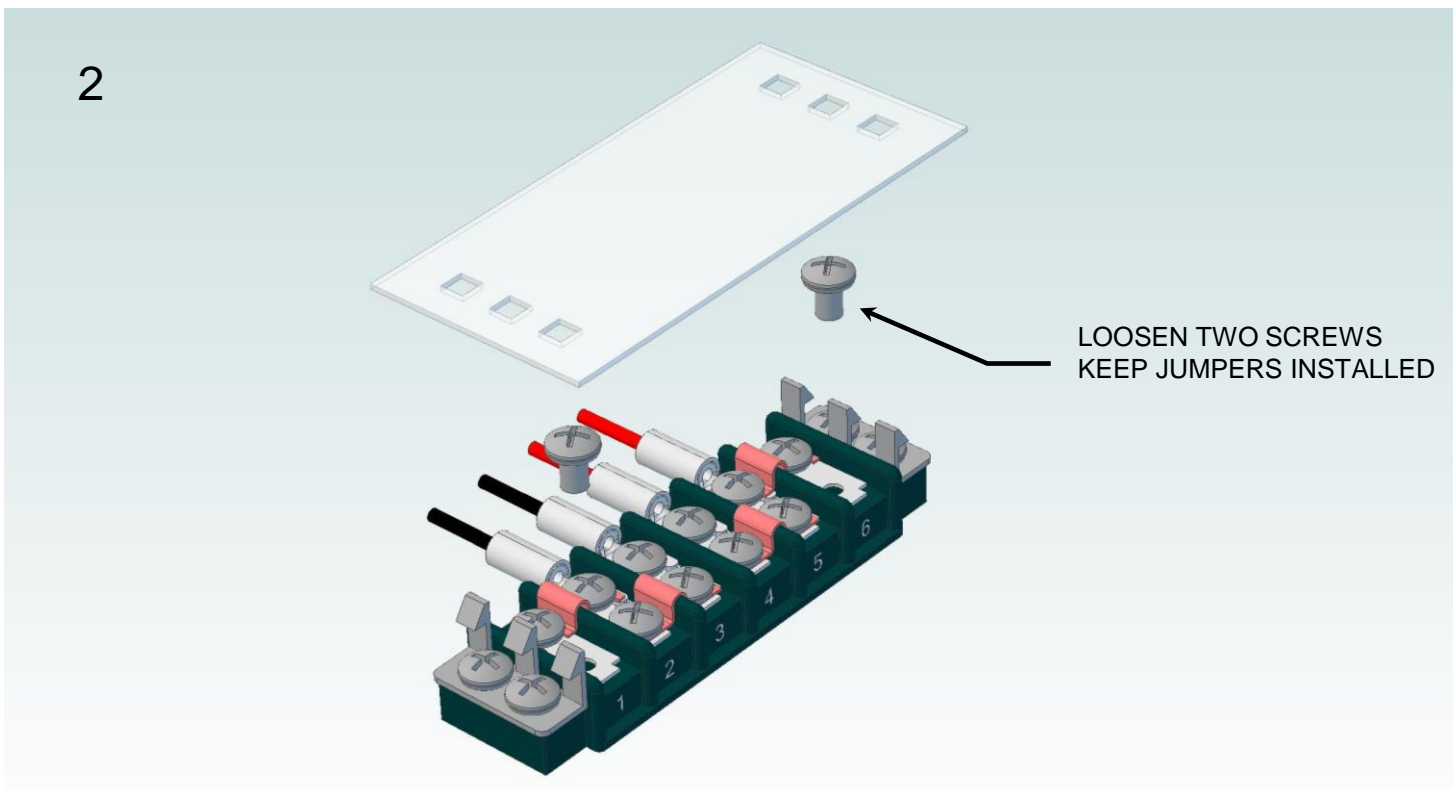
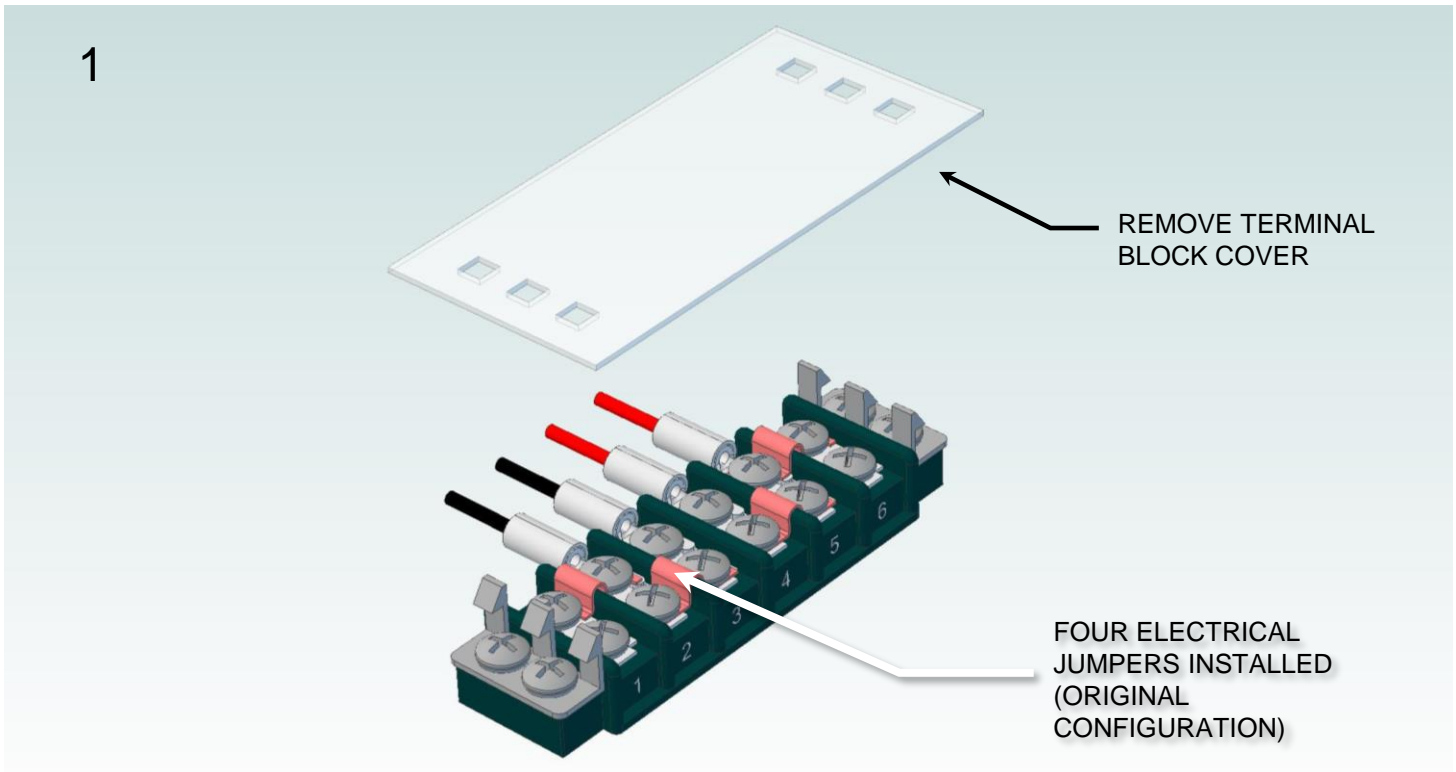

TE TECHNOLOGY, INC.®

Expert Engineering, Precision Manufacturing:
Quality Thermal Solutions Delivered

<https://tetech.com/> • cool@tetech.com • 231-929-3966 • 1590 Keane Drive • Traverse City, MI 49696

Terminal Block Configuration for Continuous Operation at Full Power

2 of 2

3

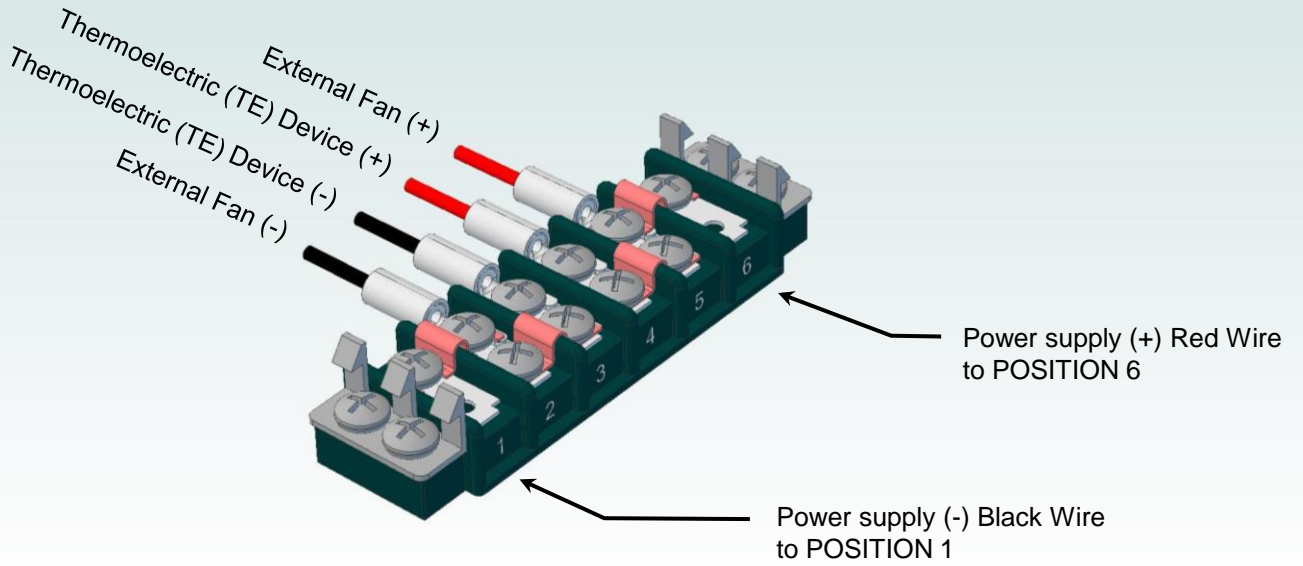

4

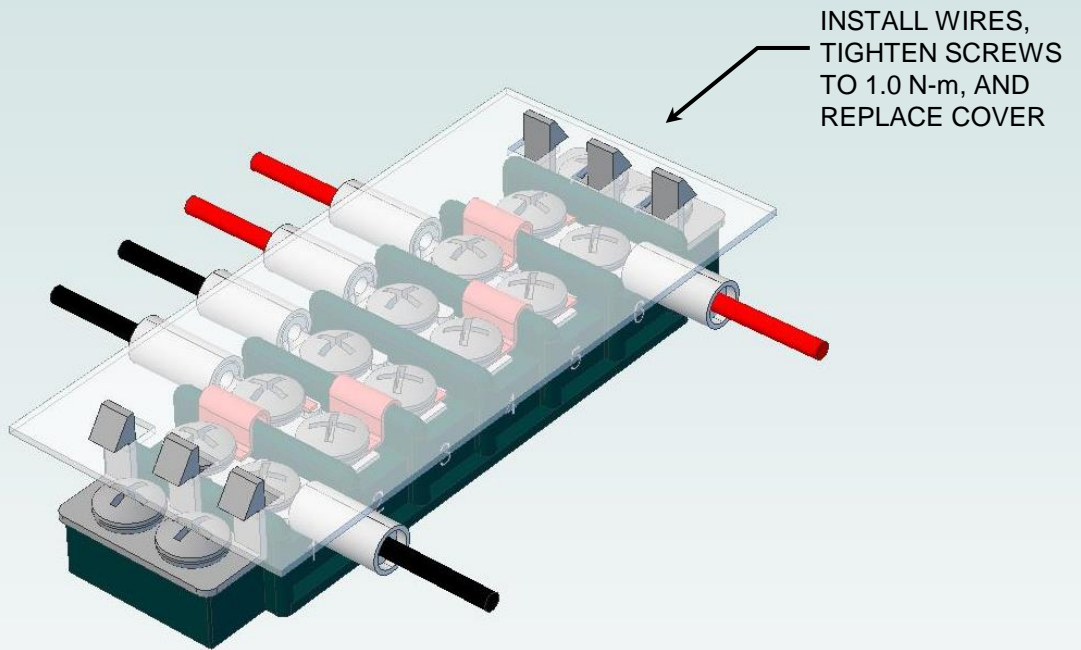

TE TECHNOLOGY, INC.®

Expert Engineering, Precision Manufacturing:
Quality Thermal Solutions Delivered

<https://tetech.com/> • cool@tetech.com • 231-929-3966 • 1590 Keane Drive • Traverse City, MI 49696

Terminal Block Configuration for Operation with Temperature Controller

1 of 2

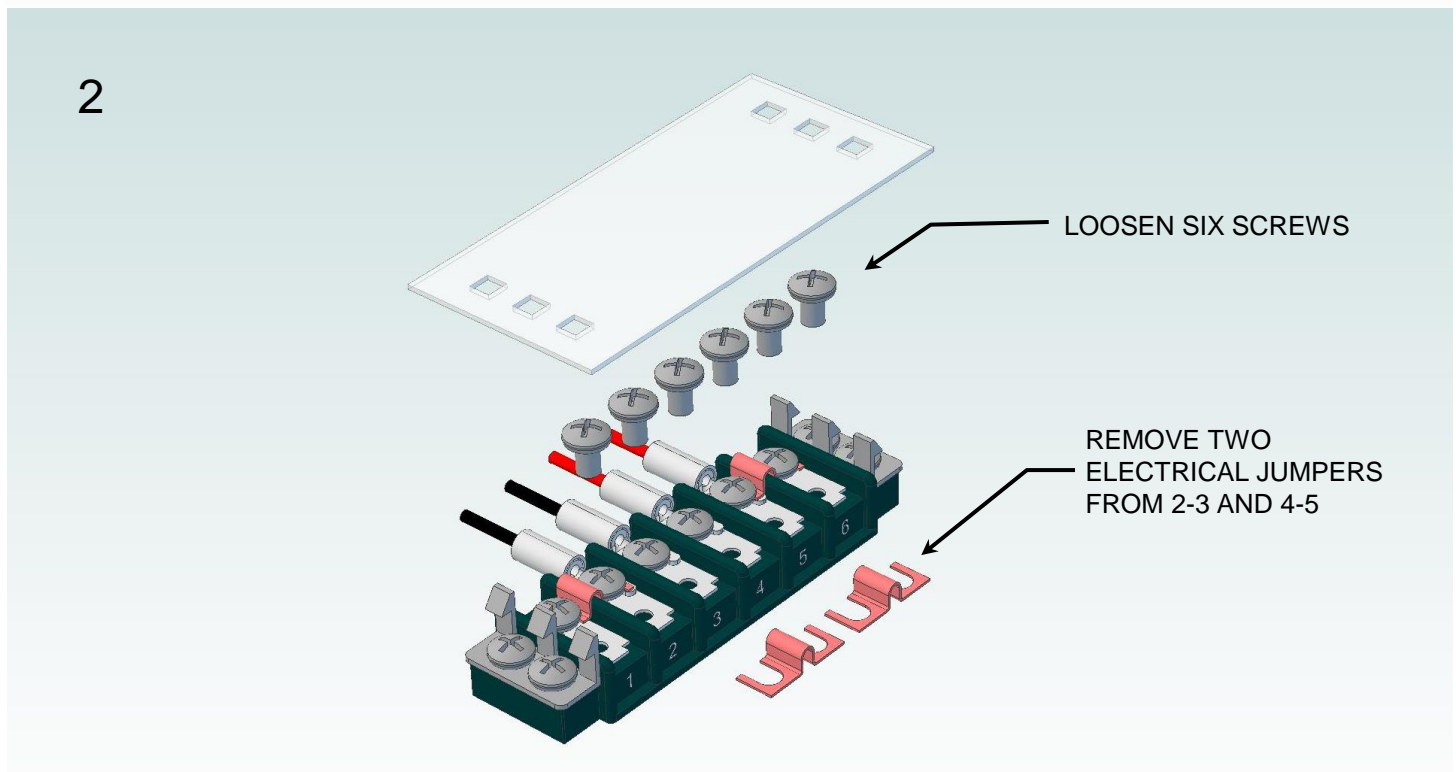
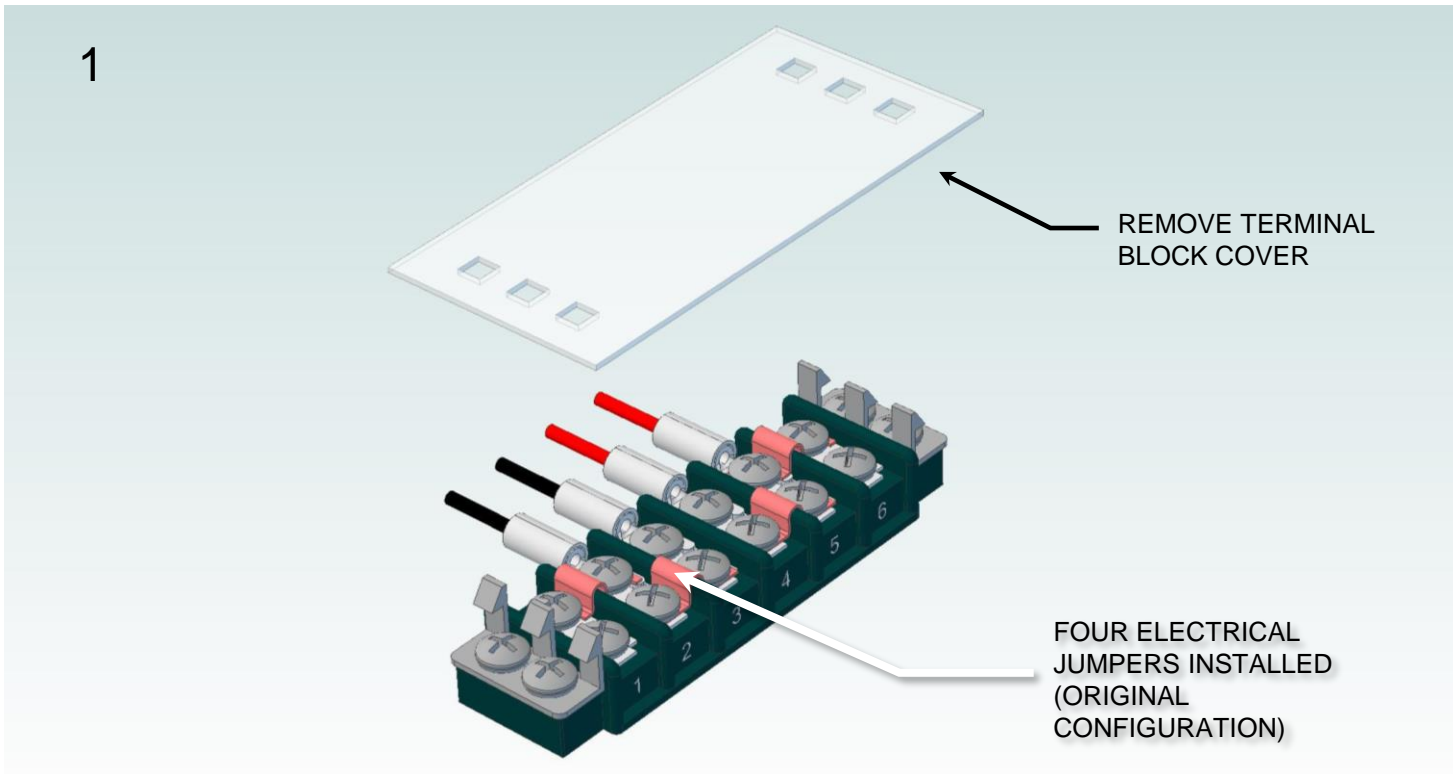

Terminal Block Configuration for Operation with Temperature Controller

2 of 2

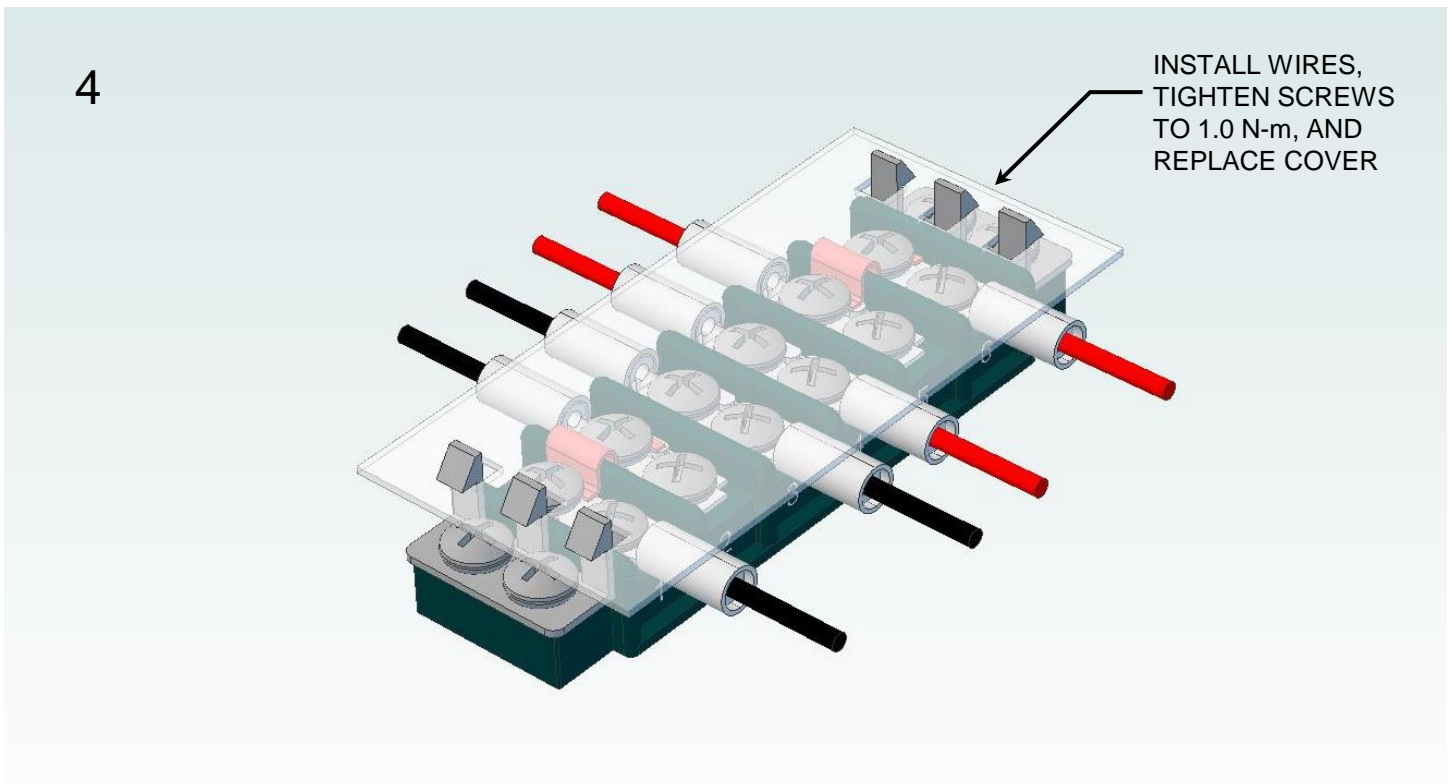
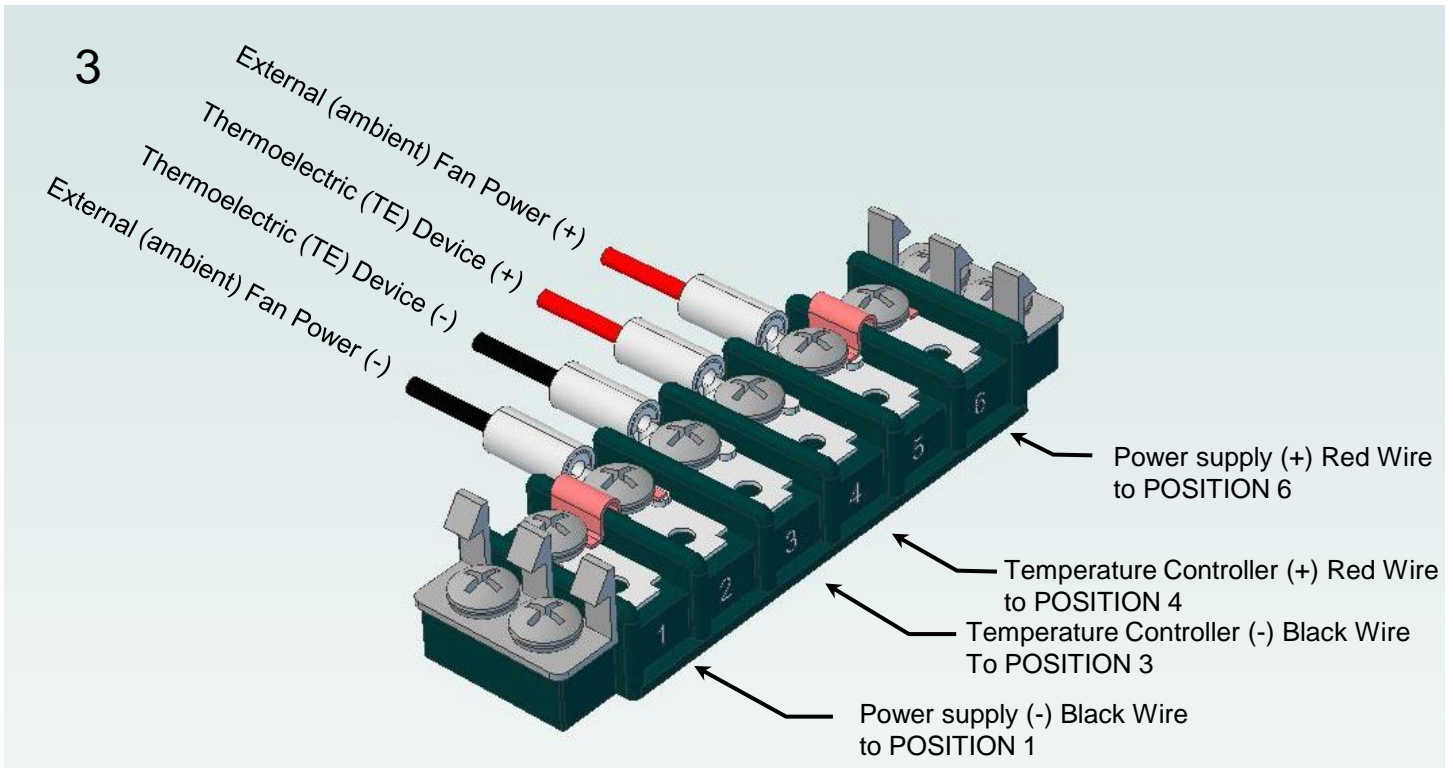

Expert Engineering, Precision Manufacturing:
Quality Thermal Solutions Delivered

<https://tetech.com/> • cool@tetech.com • 231-929-3966 • 1590 Keane Drive • Traverse City, MI 49696