

**Instruction Manual
for
Model TC-24-10
Thermoelectric Cooler
Temperature Controller**

**October 16, 2015
Drawing #3170 Rev. I**



1590 Keane Drive
Traverse City, MI 49696 USA
Web: www.tetech.com

Phone: (231) 929-3966
Fax: (231) 929-4163
e-mail: cool@tetech.com

All Materials Copyright © 2012, TE Technology, Inc.

General Safety Warnings



This manual is available in English only. It must be read and followed carefully before installation and operation.



THE LATEST REVISION OF THIS MANUAL IS AVAILABLE AT www.tetech.com. Verify that you are using the latest revision available.



The TC-24-10 should not be used as a toy, or serious injury could result. The TC-24-10 should only be used for its intended purpose of providing temperature control of TE Technology's thermoelectric devices only. The controller is intended for light industrial, laboratory, or similar use. It is not intended for household use or medical use.



Do not use in an explosive or potentially explosive environment.



Do not use the TC-24-10 to control capacitive or inductive loads or the controller could be damaged and/or overheat. Examples of capacitive or inductive loads include but are not limited to motors, fans, filters, and solenoids.



Do not allow the electrical connections on the printed circuit board to touch any electrically conductive surfaces.



Do not operate in an environment where the controller could come in contact with condensation, water, metal shavings, dirt or other contaminants, or electrically conductive materials.



Use ESD (Electro Static Discharge) protection when coming in contact with electrical connections or components on the controller.



Do not touch any of the electrical connections or components of the TC-24-10 while the controller is energized. Doing so can disrupt the function of the controller.



Do not use if the controller has been damaged in any way.



Only qualified technicians should install and operate this controller with the appropriate personal protective equipment.



Improper tuning of this temperature controller can lead to excessive thermal cycling and/or overheating of the thermoelectric device, either of which are known to reduce the lifetime of any thermoelectric device. Care should be taken to prevent the temperature of the thermoelectric device from going beyond the range specified by the device manufacturer. Care should also be taken so that any thermal cycling of the thermoelectric device is a result of changes in the controller's set-point temperature and not instability at a given set point due to improper selection of the tuning variables.



The temperature controller base underneath the transistor-mounting area could exceed 60 °C under normal operation. Use caution! Protect against accidental contact with hot surfaces.



Use protection devices to prevent hazardous conditions and/or damage to equipment.



Each power input that is used with the controller must be fused separately. Alternatively, a power supply with integral over-current protection may be used if it is appropriately sized for protecting the controller/TE device.



WP5 (+ power in) and WP1 (+ load output) are connected to each other inside the controller. When WP5 is energized a voltage will be present on WP1, even if the output is off or the controller is being used with two power supplies.



The temperature controller is intended to be used with, or incorporated into, other machinery made by TE Technology, Inc. and must not be put into service until the relevant machinery into which it is to be incorporated into has been declared in conformity with the essential requirements of the Machinery Directive 2006/42/EC.

For more information regarding protection devices read TE Technology's Thermoelectric Cooling Assembly (TCA) Instruction manual which is available for download from TE Technology's website at www.tetech.com. The terms and provisions relating to protection devices as provided in the TCA Instruction manual are hereby incorporated by reference. A copy of the TCA Instruction manual can also be sent via regular mail upon request.

TE Technology, Inc. does not make any warranty, expressed or implied, that the use or operation of the equipment will be functional or effective if the equipment is not installed and used in accordance with this manual.

TE Technology, Inc. shall not be liable, and Purchaser shall defend, hold harmless, and indemnify TE Technology, Inc. from and against, any losses, costs, expenses (including reasonable attorneys' fees), injuries, liabilities or damages of any kind or nature whatsoever, arising out of the use or inability to use this TE Technology, Inc. product, from the omission or failure to use protection devices, or from failure to comply with this manual. This provision is in addition to any other indemnification provisions which are a part of the Purchase Order or contract with Purchaser.

Table of Contents

Features	5
Operating Instructions	8
1.0 Setup	8
2.0 Control Function Description	14
3.0 Controller Tuning	15
Controller Wiring Diagram (One Power Supply Setup)	17
Controller Wiring Diagram (Two Power Supplies Setup).....	18
Mechanical Package Drawing	19
Temperature vs. Sensor/Potentiometer Voltage (graphs).....	20
Temperature vs. Sensor/Potentiometer Voltage (table).....	21
Thermistor Styles for TC-24-10	22

Features

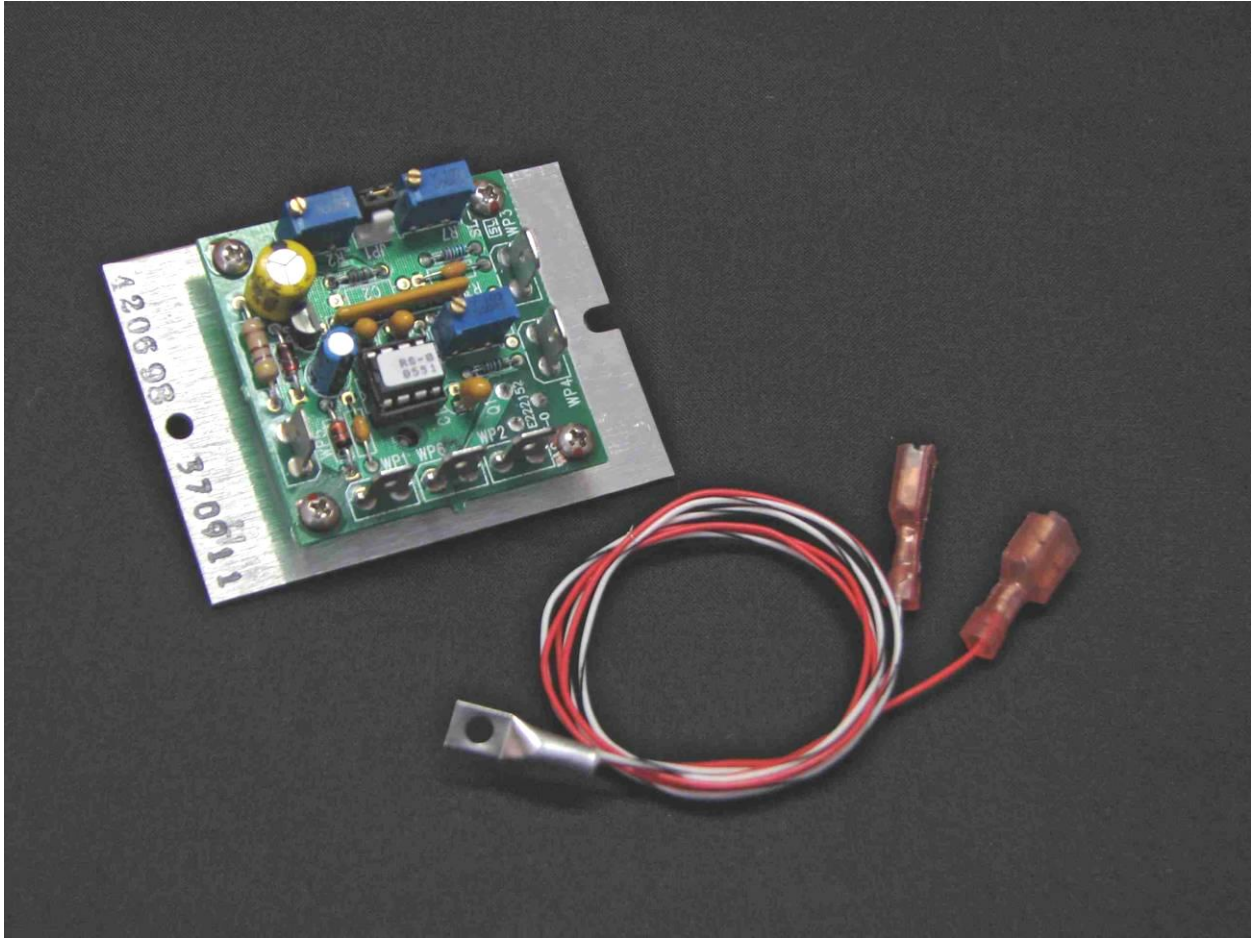

TC-24-10 Temperature Controller

The TC-24-10 is a heat- or cool-only temperature controller for thermoelectric (TE) devices. It can also be used with resistive heaters. The basic components of the TC-24-10 are a microprocessor, a thermistor input, a power output stage, and potentiometers located on the controller's circuit board to adjust the temperature set point, proportional bandwidth, and integral gain settings. While the TC-24-10 lacks some of the features found in our more sophisticated controllers, such as having a display or being able to directly interface with a computer, its low cost makes it ideal for projects that have limited budgets.

Mechanically, the controller's printed circuit board is mounted to a metal bracket. It can be mounted either horizontally or vertically. The controller can operate in ambient temperatures from 0 °C to 50 °C without generally requiring additional heat sinking. The controller is intended to be used in locations where the controller can be protected by a secondary enclosure or other means of protection.

Main Features

- Single or dual power supply input configuration:
 - Single power supply configuration:
(9 to 26) VDC, powering both controller and TE device
 - Dual power supply configuration:
(9 to 26) VDC at 0.15 A for controller circuitry,
(0 to 40) VDC for TE device
- Maximum output current: 10 A (Note: controller does not have current limiting capability)
- Heat-only or cool-only control modes, selectable by jumper switch
- Temperature control range: $-20\text{ }^{\circ}\text{C}$ to $+100\text{ }^{\circ}\text{C}$, requires the MP-3238 thermistor (supplied with the controller), or its electrical equivalent
- Best-case control stability $\pm 0.5\text{ }^{\circ}\text{C}$ (when controlling a cold plate)
- Proportional (P) bandwidth adjustment: $0.5\text{ }^{\circ}\text{C}$ to $5.0\text{ }^{\circ}\text{C}$
- Integral Rate (I) adjustment: 0 to 2.55 repeats per minute
- Output: Square wave, 1000 Hz, Pulse-width modulated
- Operating temperature range $0\text{ }^{\circ}\text{C}$ to $50\text{ }^{\circ}\text{C}$ ambient (with aluminum mounting plate in a vertical position allowing free air convection)
- 0.25 inch quick connect terminals for power, cooler, and thermistor connections
- RoHS compliant

The controller's operating temperature range is $0\text{ }^{\circ}\text{C}$ to $50\text{ }^{\circ}\text{C}$ ambient. The range can be extended to $70\text{ }^{\circ}\text{C}$ with proper heat-sinking. If the controller is to operate in an ambient greater than $50\text{ }^{\circ}\text{C}$, consult with TE Technology engineers for further assistance. See "*Mechanical Package Drawing*" for dimensional information on the controller.

For high-volume applications the controller can be customized:

- ✓ Adjustment potentiometers can be replaced with preprogrammed set-point and tuning parameters
- ✓ Resistance versus temperature curves for other types of thermistors can be programmed

Pulse-width modulated power output

The controller regulates the output power to the TE using a method called pulse-width modulation (PWM). With PWM, power to the TE device is switched quickly “ON” and “OFF” at a constant frequency (1000 Hz for this controller). This creates a square wave “pulse” of power with a constant time period. The “ON” time, or pulse width, can be varied to create an average output voltage (V_{average}) that is required by the TE device to maintain the set temperature.

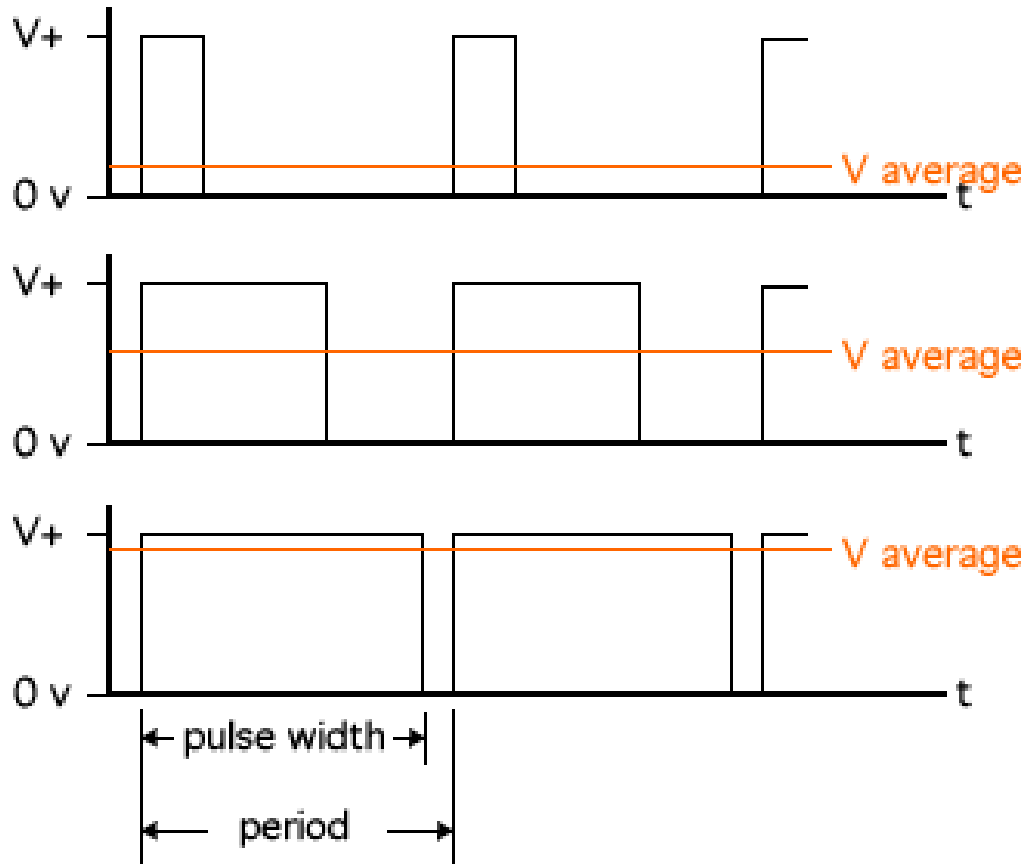

The important advantage to PWM is that it does not cause the extreme temperature excursions that are experienced with a thermostatic control system. This helps to extend the life and reliability of the TE devices. An added benefit is that the controller does not generate a large amount of waste heat, so a large heat sink is not usually required.

Multiple Control Configurations

The controller can be used with either one power supply for powering the controller electronics and the TE device together or with two power supplies for powering the controller electronics and TE device independently. Whether the controller is configured to use one or two power supplies, the TE device should not be allowed to draw more than 10 A at its rated voltage.

When using one power supply, the input voltage is passed directly through the controller to the TE device during “ON” pulse. The controller electronics operate within a (9 to 26) V range, so the TE device must likewise be rated for at least 9 V, but no more than 26 V.

If the TE device operates on less than 9 V, the TC-24-10 can be configured to use two power supplies. The power supply for the controller electronics must be able to provide (9 to 26) V at 150 mA current minimum. The power supply for the TE device can then be selected to provide the appropriate voltage ranging from (0 to 40) V.

Regardless of whether you use one or two power supplies, when making a cooling system from a single TE module, the maximum operating voltage for that *system* is usually no more than 75% of the rated V_{max} of the TE module. The 75% rule is based on the TE module being thermally connected to a “good” heat sink; system modeling should be done to verify this rule is applicable though. If multiple TE modules are used in a series or series-parallel combination, the V_{max} of the system will be approximately 75% of the rated V_{max} of each TE module multiplied by the number of modules in series.

Operating Instructions

1.0 Setup



Portions of the temperature controller (the aluminum frame near the output transistors, for example) could exceed 60 °C during normal operating conditions. Temperatures greater than 60 °C can result in a hazard to the user. Use caution! Protect against accidental contact with hot surfaces.



If the temperature controller is to be used under conditions such that its surface temperatures could possibly exceed 60 °C, test the surface temperatures under the worst-case operating conditions of maximum ambient temperature and highest output current and voltage. If any portion of the temperature controller exceeds 60 °C place adequate guards around the temperature controller to prevent contact with any hot surfaces.



NOTE: the maximum allowable ambient temperature for the controller is 50 °C. Furthermore, the maximum allowable temperature of the controller base (underneath the transistor-mounting area) is 90 °C. Furthermore, the controller might need additional heat sinking, depending on ambient conditions and how much current is being drawn by the TE device.

Note: See “Controller Wiring Diagram (One Power Supply Setup)” or “Controller Wiring Diagram (Two Power Supplies Setup)” for additional reference.

1.1 Set the position of jumper JP1.

- To set the controller in cooling mode: JP1 is shorted (jumper is installed)
- To set the controller in heating mode: JP1 is open (jumper is removed)

1.2 Attach the thermistor at an appropriate temperature-control location. Locating the thermistor at the cold side of the TE device provides better control stability than locating it at the object, liquid, or air that is to be cooled/heated. However, in doing so, there will be a temperature difference between the TE device and the object, liquid, or air that is to be cooled/heated. The temperature set point can be adjusted to compensate for this temperature difference if necessary.

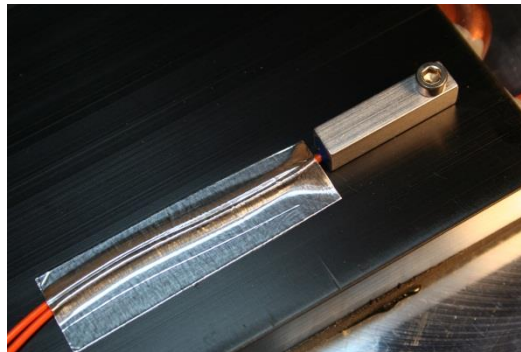

NOTE: When possible, it is recommended that at least 50 mm of the thermistor’s wire be thermally connected to the cold side of the TE device. This can be accomplished by placing aluminum tape over the thermistor wires and adhering the wires and tape to the cold side of the cooler. If this is not done, the thermistor wires will be at a different temperature than the cold side and they will add or remove heat in

the region of the thermistor, making the temperature reading **significantly less accurate** and thermal response time slower.

The TC-24-10 is supplied with the MP-3238 thermistor. Other thermistor styles directly compatible with the controller are available as options. See “*Thermistor Styles for TC-24-10*” for reference.

If you want to use a thermistor that has a different resistance-temperature curve from the standard MP-3238 (See “*Temperature versus Resistance for MP-3238, MP-2444, and MP-2542 Thermistors*” for reference), it can be done as long as the operating resistance range is within that of the standard thermistor. The thermistor must be a negative temperature coefficient device. Because the temperature controller is really measuring the thermistor’s resistance and converting this to a temperature, the temperature controller will be fooled into thinking that the thermistor is at a different temperature than it really is, and the Set-Temperature will be skewed accordingly. A loss of resolution and control stability may occur as a result. The user assumes all risks associated with making any substitutions, and TE Technology assumes no liability whatsoever for the operation of the controller when a non-standard thermistor is used.

1.3 Connect the thermistor wire leads to WP3 and WP4.

1.4 The TC-24-10 can be used with two separate power supplies which allows for the control of TE devices whose nominal operating voltage is less than 9 V. In this case, one power supply is for the TE device, and the other power supply is for the controller itself (the microprocessor and associated electronics). Of course, a single power supply can be used for powering both the controller and the TE device provided that the TE device’s nominal operating voltage is ≥ 9 V and ≤ 26 V.



When using one power supply for powering the controller and the TE device together, the power supply input voltage is passed directly through the controller to the TE device during the “ON” pulse. The user should choose an input voltage that is required for the TE device and yet is also ≥ 9 V but ≤ 26 V. The controller could be damaged if operated outside this voltage range.



When using two power supplies, the controller input power supply must be ≥ 9 V and ≤ 26 V at 150 mA minimum current. The power supply input voltage for the TE device can be ≥ 0 V but ≤ 40 V.



The maximum allowable current through the controller is 10 A. The maximum allowable current draw for the TE device must therefore also be less than 10 A. The 10 A limit applies regardless of whether you are using one power supply or using two independent power supplies.



The controller does not have an internal fuse or circuitry to limit current. Therefore, an external fuse, appropriately sized for protecting the controller/TE device, should be connected between the power supply and the controller to prevent damage to the controller/TE device and to prevent injury to the user should an over-current condition occur. Alternately, a power supply with integral over current protection can be used if it is appropriately sized for protecting the controller/TE device.



When making a cooling system from a single TE device, the maximum operating voltage for that system is usually no more than 75% of the rated V_{max} of the TE module. The 75% rule is based on the TE module being thermally connected to a “good” heat sink; system modeling should be done to verify this rule is applicable though. If multiple TE modules are used in series or series-parallel combination, the V_{max} of the system will be approximately 75% of the rated V_{max} of each TE module multiplied by the number of modules in series. Applying a voltage greater than the system maximum will not necessarily damage the controller (unless voltage and/or current limits are exceeded), but the TE device could be damaged by overheating as a result.



Power supply and TE Device wire leads should be kept as short as possible to minimize electrical losses and reduce the likelihood of generating unwanted electromagnetic interference. Wire length must not exceed one meter. Use wires of a sufficient gage appropriate to the amount of electrical energy each wire is to carry. Wire insulation and size must also be appropriate to the ambient temperature and/or temperature of objects in contact with the wire. Wire leads supplied by TE Technology are for prototyping purposes and should be reviewed for appropriateness in the final application.



Use protection devices to prevent hazardous conditions and/or damage to the load (e.g. cooling assembly, heater, etc.) and other related equipment. Protection devices must operate independently of the temperature controller circuitry. Protection devices should be placed at all points on the load and related equipment where a hazardous condition can be detected. These protection devices should de-energize the TC-24-10, the load, and, as necessary, other related secondary equipment. It is further recommended that such devices require the user to remove and correct the root cause of a fault before allowing the TC-24-10, the load, and related equipment to be re-energized. Protection devices should include, but are not limited to:

- Fuses to prevent against electrical overloads,
- Over/under temperature thermostats to prevent against hazardous and/or damaging temperatures,
- Liquid flow meters to prevent against damage due to loss of coolant flow

The TC-24-10 controller (in conjunction with the standard and optional sensors) can not detect under-temperature and over-temperature conditions. Therefore, hazards and/or risk of loss or damage to the load (e.g. cooling assembly, heater, etc.), and/or secondary equipment could occur if the temperature controller and/or sensors were to malfunction. Therefore, independent, redundant protection devices are recommended in addition to the safeguards provided by the temperature controller.

1.4.1 One Power Supply Operation:



Make sure the power supply is **NOT** energized while making electrical connections to the controller.



Power supply should be of voltage needed for TE device.



If voltage is not between 9 V to 26 V then a two power supply configuration is necessary.

- c) Connect the constant DC voltage power supply, (9 to 26) V to the controller:
 - Positive (+) power supply terminal to WP5
 - Negative (-) power supply terminal to WP6
 - Turn on the power supply to the controller.
- b) Do **NOT** connect the TE device to the controller at this time.
- c) See the “*Controller Wiring Diagram (One Power Supply Setup)*” for further details.

1.4.2 Two Power Supplies Operation:



Make sure the power supplies are **NOT** energized while making electrical connections to the controller.

- c) Connect the constant DC voltage power supply (9 to 26) V, 150 mA minimum to the controller (for powering the controller):
 - Positive (+) power supply terminal to WP5
 - Negative (-) power supply terminal to WP6
 - Turn on the power supply to the controller.
- b) Connect the constant DC voltage power supply (0 to 40) V to the controller (for powering the module):
 - Negative (-) power supply terminal to WP6
 - NOTE:** both power supplies must connect their negative terminals to WP6
- c) Do **NOT** connect the TE device negative (-) terminal to the controller at this time.
- d) See the “*Controller Wiring Diagram (Two Power Supplies Setup)*” for further details.

- 1.5 Turn on the power supply to the controller, and adjust the temperature set point using potentiometer R7. The potentiometer range corresponds to -20 °C at full counter-clockwise to +100 °C at full clockwise. This is a 25-turn potentiometer, so each full turn corresponds to a 4.8 °C change in the set point.



Verify that the set point is set to a temperature that is within the allowable temperature range of the TE device. **DO NOT CONNECT THE TE DEVICE TO THE OUTPUT OF THE CONTROLLER UNTIL THE APPROPRIATE CONTROL TEMPERATURE HAS BEEN SET.**

The TC-24-10 does not have a display for indicating the set temperature or sense temperature. However, you can measure the sensor (thermistor) voltage across WP3 to WP4, and the set point voltage across Pin 2 (+) to Pin 3 (-) on potentiometer R7. The “*Temperature vs. Sensor/Potentiometer Voltage*” graphs and tables show the relationship between voltage and temperature for the sensor and the set point.

- 1.6 Turn off the power to the controller and connect the TE device to the controller:

COOLING MODE:

One Power Supply Operation

- a) Connect the positive terminal (+) of **ONLY** the TE device to WP1.
- b) Connect the negative terminal (-) of **ONLY** the TE device to WP2.
- c) Verify that JP1 is shorted (that is, a jumper is installed, which is the factory default).

Two Power Supplies Operation

- a) Connect the positive (+) terminal of **ONLY** the TE device to the positive terminal of the power supply that will be used for the TE device.
- b) Connect the negative (-) terminal of **ONLY** the TE device to WP2.
- c) Verify that JP1 is shorted (that is, a jumper is installed, which is the factory default).

HEATING MODE:

One Power Supply Operation

- a) Connect the positive terminal (+) of **ONLY** the TE device to WP2.
- b) Connect the negative terminal (-) of **ONLY** the TE device to WP1.
- c) Verify that JP1 is open (that is, no jumper is installed).

Two Power Supplies Operation

- a) Connect the negative (-) terminal of **ONLY** the TE device to the positive terminal of the power supply that will be used for the TE device.
- b) Connect the negative (+) terminal of **ONLY** the TE device to WP2.
- c) Verify that JP1 is open (that is, no jumper is installed).



TE Technology's standard thermoelectric cooling assemblies (TCA) have at least one fan on the heat sink. The standard configuration has the thermoelectric modules and fan(s) wired to a terminal block with jumpers across the terminals so that the fans and modules are connected in parallel. However, this configuration is applicable only when applying power directly from the power supply. When using the TCA with the temperature controller, the jumpers **MUST** be removed so that the controller is controlling power only to the thermoelectric modules. There must be no electrical connection between the fans and the modules; fans must be connected directly to the power supply, not to the controller. *The controller will be damaged if this is not followed.* See the cooler manual for further details, but the picture below shows the basic setup.

Temperature Controller Connection

Review electrical jumper connections. Remove electrical jumpers as required.

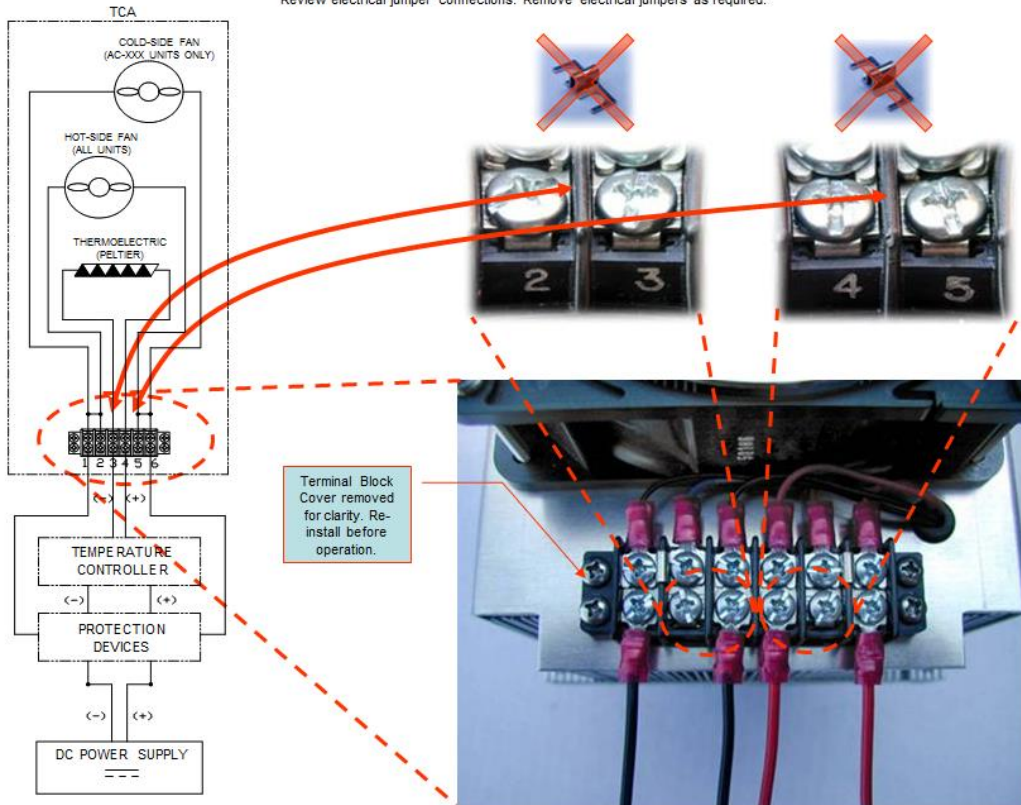

- 1.7 Turn on power supply to the controller (and power supply to the TE device if applicable), and set tuning parameters as necessary. Controller tuning is discussed in section 3.



Do not mount the controller to a surface which is exposed to a source of heat, such as from electronics, machinery, or solar radiation.



Do not cover the controller with any object or otherwise restrict natural convection airflow around the controller. Doing so could cause the controller to overheat.



Do not mount the controller to an insulating surface. Doing so could cause the controller to overheat.



Do not operate the controller in such a manner as to cause the surface temperature of the circuit board or its frame to reach 70 °C. Otherwise the controller might be damaged and there might be a risk of fire as a result.



Do not allow the controller to be exposed to water (such as from dripping or leaking water lines or from water-vapor condensation if the surface temperature of the controller is below the dew point temperature).



Do not allow metallic dust/shavings to contact the controller electronics.

2.0 Control Function Description

- 2.1 Proportional control: This eliminates much of the temperature cycling inherent in on/off control. The proportioning bandwidth is the temperature span over which the power is proportioned from 0% to 100% power, centered about the temperature set point. That is, the controller output decreases to 50% power as it reaches the set point and to 0% as it reaches the end of the bandwidth range above the set point.

For example, suppose the controller is being operated in the cooling mode, the set point is 10.0 °C, and the bandwidth is set to 5 °C. The controller power starts to proportionally decrease as the sensor temperature cools below 12.5°C. The power will be reduced to 50% when the sensor is at 10.0 °C. Finally, the power will be at 0% when the sensor is at 7.5°C. (Of course, this example presumes that the cooler would have enough capacity to cool to 7.5 °C.)

If the bandwidth is set too narrow, the temperature will oscillate around the set point. If the bandwidth is too wide, the controller will be slow to respond or may never reach set point.

- 2.2 Integral Control: This corrects for any offset between the set temperature and the sense temperature by averaging the offset with respect to time. This essentially shifts the proportioning bandwidth.

For example, suppose the set temperature is 10.0 °C, the bandwidth is set to 5 °C, and the controller settled to a constant 11.2 °C (corresponding to 74% power). If the integral control is set to 1 repeat per minute, the controller will increase the power to 98% in 1 minute. In this example, after one minute of operation the controller calculated that the error from the desired temperature to actual temperature was +1.2 °C above set point. With a bandwidth of 5 °C, the controller then calculated that it needed an additional 24% output ($100\% \text{ output} / 5 \text{ }^\circ\text{C} * 1.2 \text{ }^\circ\text{C} = 24 \%$). This additional 24% output was added to the existing 74% output to yield 98% output. The integral portion of the output is recalculated at the frequency specified by the integral potentiometer. Thus, at the next update period for the integral the controller will add or subtract as necessary from the 98% output. Of course, the maximum output is limited to 100% and the minimum is limited to 0%.

If the integral control is set too high, the temperature will oscillate. If integral control is set too low, it will take a long time for the temperature to settle to steady state.

3.0 Controller Tuning

Tuning of Proportional and Integral (PI) control requires knowing two parameters:

1. The natural period of the system, and
2. The bandwidth used to achieve this cycle.

This tuning method follows the Ziegler Nichols closed-loop tuning principals. Briefly, the controller will first be set to a low gain (high Bandwidth) setting with no integral function (Integral rate = 0). Then, the gain is gradually increased until the temperature approaches set point, and a small, sustained oscillation in temperature is observed. The tuning parameters are then readjusted based on the time period of the temperature oscillation (natural period) and the Bandwidth needed to cause this oscillation.



Improper tuning of this temperature controller can lead to excessive thermal cycling and/or overheating of the thermoelectric device, either of which are known to reduce the lifetime of any thermoelectric device. Care should be taken to prevent the temperature of the TE device from going beyond the range specified by the device manufacturer. Care should also be taken so that any thermal cycling of the TE device is a result of changes in the controller's set-point temperature and not instability at a given set point due to improper selection of the tuning variables.

The potentiometers used on this controller are 25-turn devices. When the potentiometer has been adjusted to the "maximum clockwise" or "maximum counterclockwise" position, the adjustment pawl will ratchet on the screw-driven gear, making a slight clicking sound.

- 3.1 Set the Integral Rate Potentiometer (R8) to zero by adjusting it to maximum counterclockwise.
- 3.2 Set the Proportional Bandwidth Potentiometer (R2) to 5 °C by adjusting it to maximum clockwise.
- 3.3 Set the desired control temperature by adjusting the Set Temperature Potentiometer (R7). See the "*Temperature vs. Sensor/Potentiometer Voltage*" graphs and tables for the potentiometer voltage-set point relationship.
- 3.4 Adjust the Proportional Bandwidth Potentiometer counterclockwise until a small, sustained temperature oscillation is observed. (You can adjust in initial increments of 1 V, or 5 turns. Then, once an initial oscillation is observed, adjust the potentiometer clockwise until the oscillations are barely detectable).
- 3.5 Record the number of turns (counterclockwise from the maximum clockwise position) on the Proportional Bandwidth Potentiometer that are required to barely sustain this temperature oscillation.

_____ Turns

- 3.6 Calculate the bandwidth that corresponds to this potentiometer setting using the formula: Bandwidth = 5 °C – 0.18 °C/turn x (number of turns recorded in section 3.5). (See Tuning Example below)

Bandwidth = _____ °C

- 3.7 The time that it takes to go from one peak temperature to the next peak temperature is the natural period. Record the time of the natural period in minutes.

_____ Minutes

- 3.8 Double the bandwidth calculated in section 3.6, and then adjust the Proportional Bandwidth Potentiometer to this new value. Fully counterclockwise = 0.5 °C, and fully clockwise = 5 °C. Each full turn of the Proportional Bandwidth Potentiometer corresponds to 0.18 °C increment. If doubling the bandwidth yields a value greater than 5 °C, set the bandwidth to 5 °C.
- 3.9 Calculate the inverse, or reciprocal, of the natural period recorded in section 3.7, and adjust the controller Integral Rate (the number of repeats per minute) to this value. Each full turn of the Integral Rate Potentiometer corresponds to 0.102 repeats per minute increment.
- 3.10 These Proportional and Integral settings are approximate settings and may need further minor adjustments. Record the final number of turns used on the Proportional Bandwidth Potentiometer and Integral Rate Potentiometer.

Final number of turns on the Proportional Bandwidth Potentiometer = _____ from maximum clockwise.

Final number of turns on the Integral Rate Potentiometer = _____ from maximum counterclockwise.

Additional systems with the same thermodynamic properties will operate using the Potentiometer settings listed above.

Tuning Example:

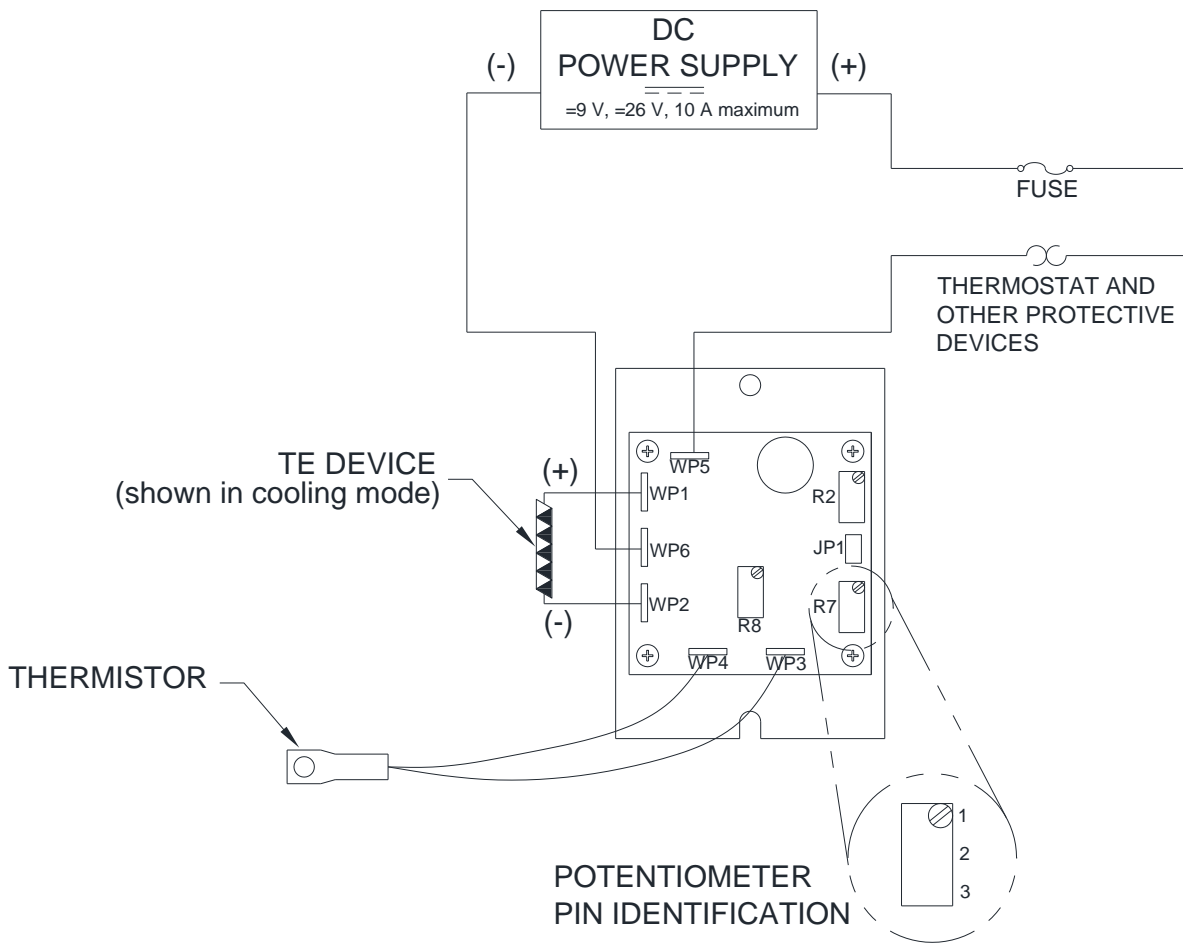

- A. Suppose that 16 counterclockwise turns of the Proportional Bandwidth Potentiometer (R2) were required to just sustain a temperature oscillation. This corresponds to a proportional bandwidth of about $(5\text{ °C} - 0.18\text{ °C/turn} \times 16\text{ turns}) = 2.1\text{ °C}$. (Reference section 3.6)
- B. It was then observed that the natural period of this oscillation was 2 minutes. (Reference section 3.7)
- C. The Proportional Bandwidth Potentiometer (R2) should be adjusted to double the bandwidth to 4.2 °C. (Reference section 3.8) This is about 20.5 turns clockwise from the full counterclockwise position $(0.5\text{ °C} + 0.18\text{ °C/turn} \times 20.5\text{ turns} = 4.2\text{ °C})$.
- D. The Integral Rate variable should be set to the inverse of the natural period by adjusting the Integral Rate Potentiometer (R8). This is $1/(2\text{ min}) = 0.5\text{ repeats per minute}$. Since each turn of the potentiometer equals 0.102 repeats per minute, the potentiometer should be adjusted 4.9 turns clockwise from the full counterclockwise position. (Reference section 3.9)

Controller Wiring Diagram (One Power Supply Setup)



Notes: R2 = Proportional bandwidth adjustment (0.5 to 5 °C), clockwise to increase
 R7 = Set-point temperature adjustment (-20 to +100 °C), clockwise to increase
 R8 = Integral rate adjustment (0 to 2.55 repeats per minute), clockwise to increase
 All potentiometers have a 25-turn adjustment range.

WP1, WP2, WP3, WP4, WP5 and WP6 are 0.25 inch quick-connect terminals

-  When one or more external fans are used on the TE device, these should be wired directly to a fixed voltage power supply for constant operation.
-  When connecting the controller to a TE Technology Thermoelectric Cooling Assembly (TCA) verify that the electrical jumpers (shorts) located on the TCA terminal block are installed/removed per the TCA operating manual before powering the controller.

Controller Wiring Diagram (Two Power Supplies Setup)

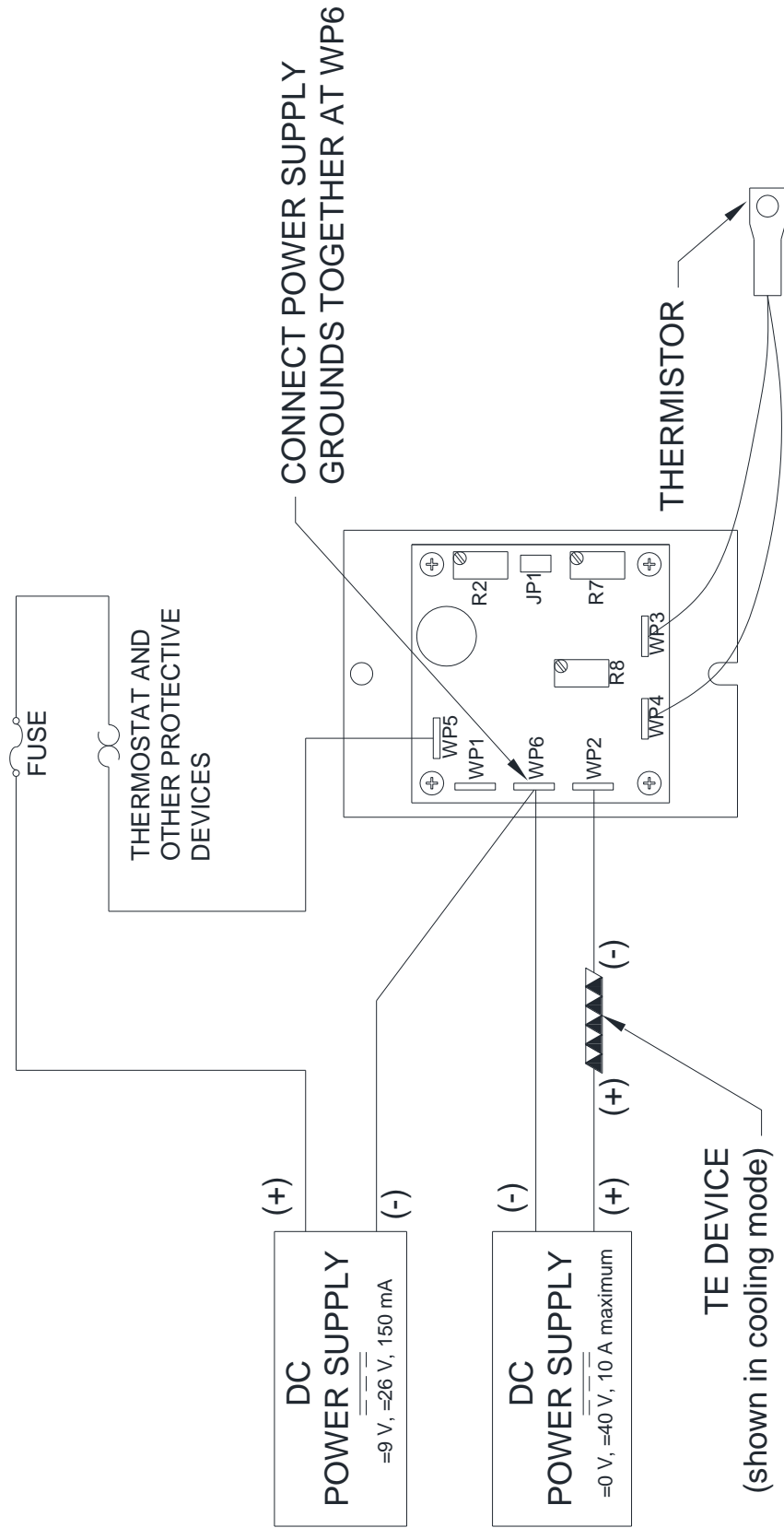

Mechanical Package Drawing

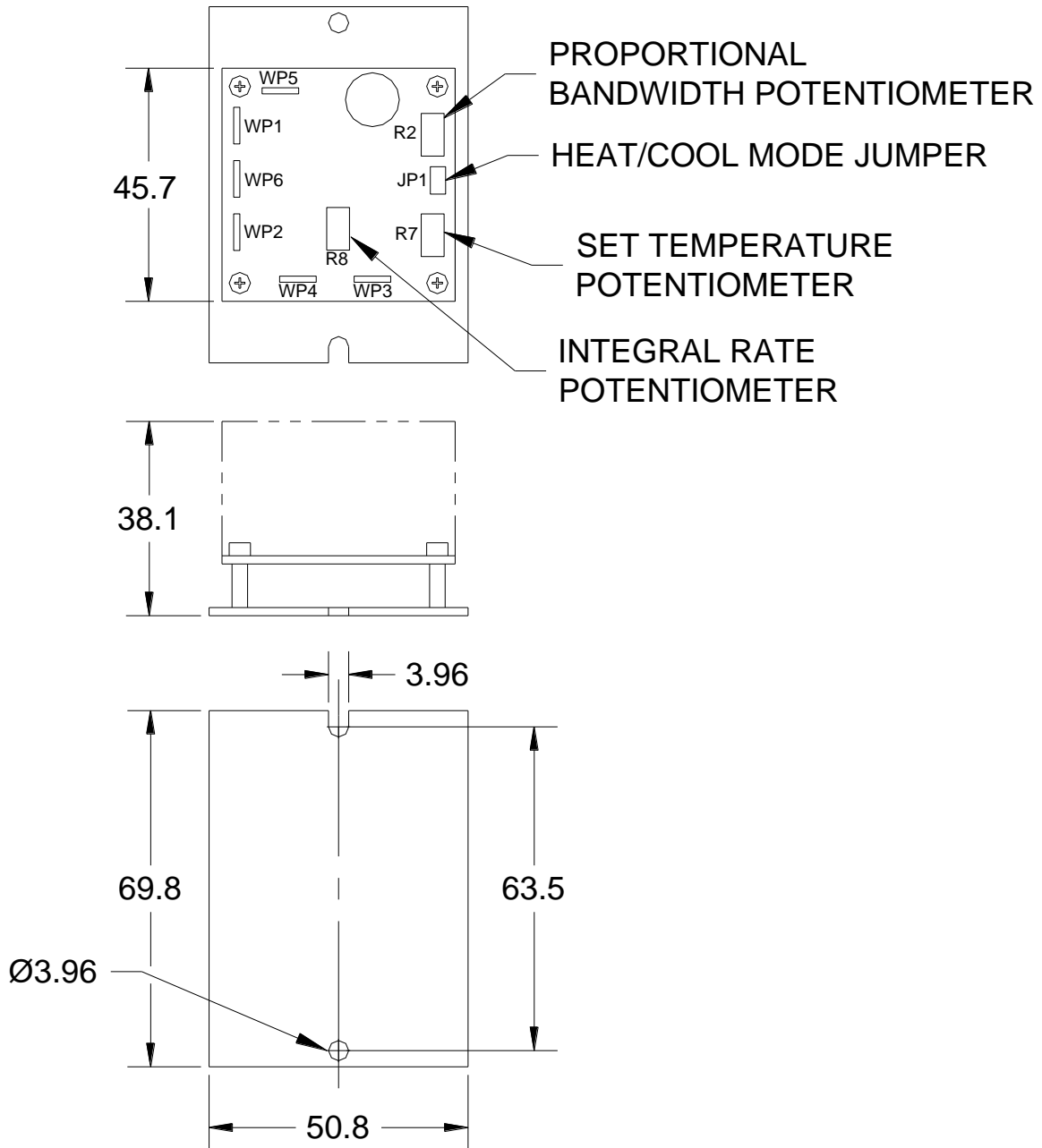

NOTE: ALL DIMENSIONS IN MILLIMETERS

Temperature vs. Sensor/Potentiometer Voltage (graphs)

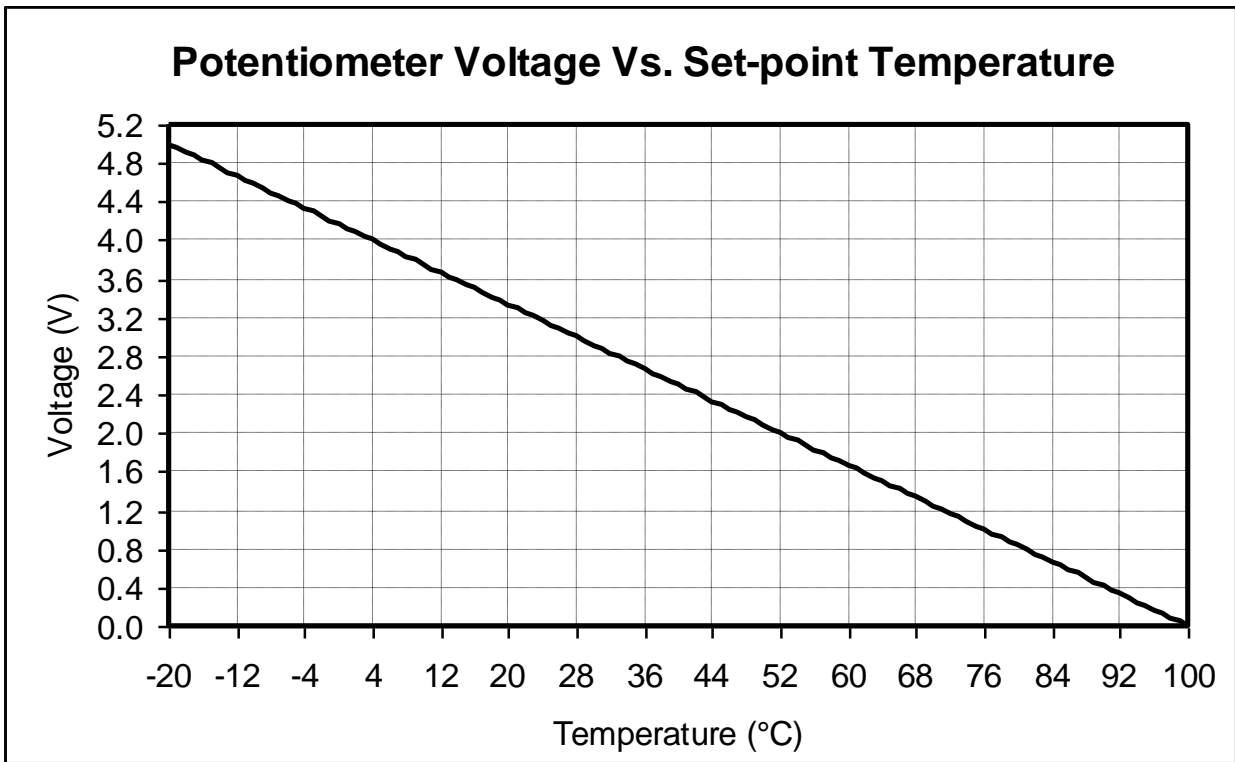
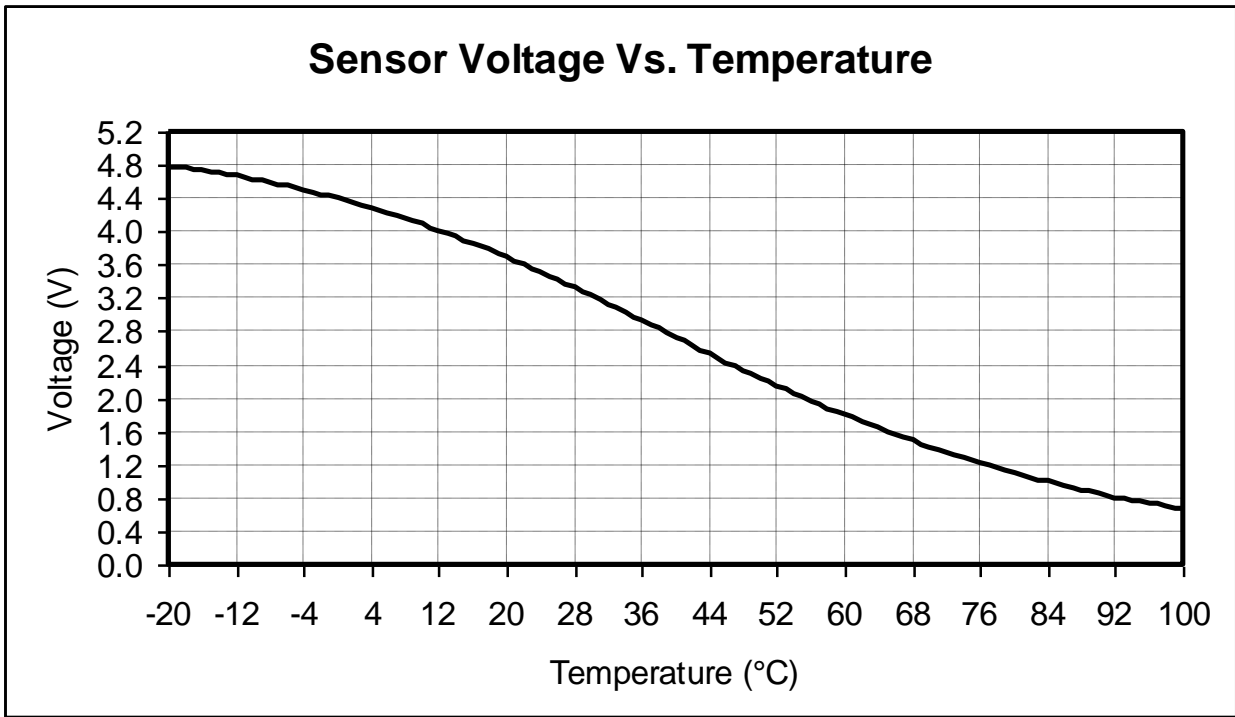

Temperature vs. Sensor/Potentiometer Voltage (table)

Sensor voltage is measured across WP3 and WP4.

Set-point voltage is measured across Pin 2 (+) and Pin 3(-) on R7 potentiometer.

<u>Temperature (°C)</u>	<u>Sensor (thermistor) Voltage (V)</u>	<u>Set-point Potentiometer Voltage (V)</u>	<u>Temperature (°C)</u>	<u>Sensor (thermistor) Voltage (V)</u>	<u>Set-point Potentiometer Voltage (V)</u>
-20	4.78	5.00	41	2.68	2.46
-19	4.77	4.96	42	2.63	2.42
-18	4.76	4.92	43	2.58	2.38
-17	4.74	4.88	44	2.53	2.33
-16	4.73	4.83	45	2.48	2.29
-15	4.71	4.79	46	2.43	2.25
-14	4.70	4.75	47	2.38	2.21
-13	4.68	4.71	48	2.34	2.17
-12	4.67	4.67	49	2.29	2.13
-11	4.65	4.63	50	2.24	2.08
-10	4.63	4.58	51	2.19	2.04
-9	4.61	4.54	52	2.15	2.00
-8	4.59	4.50	53	2.10	1.96
-7	4.57	4.46	54	2.06	1.92
-6	4.55	4.42	55	2.01	1.88
-5	4.53	4.38	56	1.97	1.83
-4	4.50	4.33	57	1.92	1.79
-3	4.48	4.29	58	1.88	1.75
-2	4.45	4.25	59	1.84	1.71
-1	4.43	4.21	60	1.80	1.67
0	4.40	4.17	61	1.76	1.63
1	4.38	4.13	62	1.72	1.58
2	4.35	4.08	63	1.68	1.54
3	4.32	4.04	64	1.64	1.50
4	4.29	4.00	65	1.60	1.46
5	4.26	3.96	66	1.56	1.42
6	4.23	3.92	67	1.52	1.38
7	4.19	3.88	68	1.49	1.33
8	4.16	3.83	69	1.45	1.29
9	4.12	3.79	70	1.42	1.25
10	4.09	3.75	71	1.38	1.21
11	4.05	3.71	72	1.35	1.17
12	4.02	3.67	73	1.32	1.13
13	3.98	3.63	74	1.28	1.08
14	3.94	3.58	75	1.25	1.04
15	3.90	3.54	76	1.22	1.00
16	3.86	3.50	77	1.19	0.96
17	3.82	3.46	78	1.16	0.92
18	3.78	3.42	79	1.13	0.88
19	3.73	3.38	80	1.10	0.83
20	3.69	3.33	81	1.08	0.79
21	3.65	3.29	82	1.05	0.75
22	3.60	3.25	83	1.02	0.71
23	3.56	3.21	84	1.00	0.67
24	3.51	3.17	85	0.97	0.63
25	3.46	3.13	86	0.95	0.58
26	3.42	3.08	87	0.93	0.54
27	3.37	3.04	88	0.90	0.50
28	3.32	3.00	89	0.88	0.46
29	3.27	2.96	90	0.86	0.42
30	3.23	2.92	91	0.84	0.38
31	3.18	2.88	92	0.81	0.33
32	3.13	2.83	93	0.79	0.29
33	3.08	2.79	94	0.77	0.25
34	3.03	2.75	95	0.75	0.21
35	2.98	2.71	96	0.74	0.17
36	2.93	2.67	97	0.72	0.13
37	2.88	2.63	98	0.70	0.08
38	2.83	2.58	99	0.68	0.04
39	2.78	2.54	100	0.66	0.00
40	2.73	2.50			

Thermistor Styles for TC-24-10

See www.tetech.com for additional thermistors

Note: all dimensions in millimeters. Some styles do not include fast-on terminals.

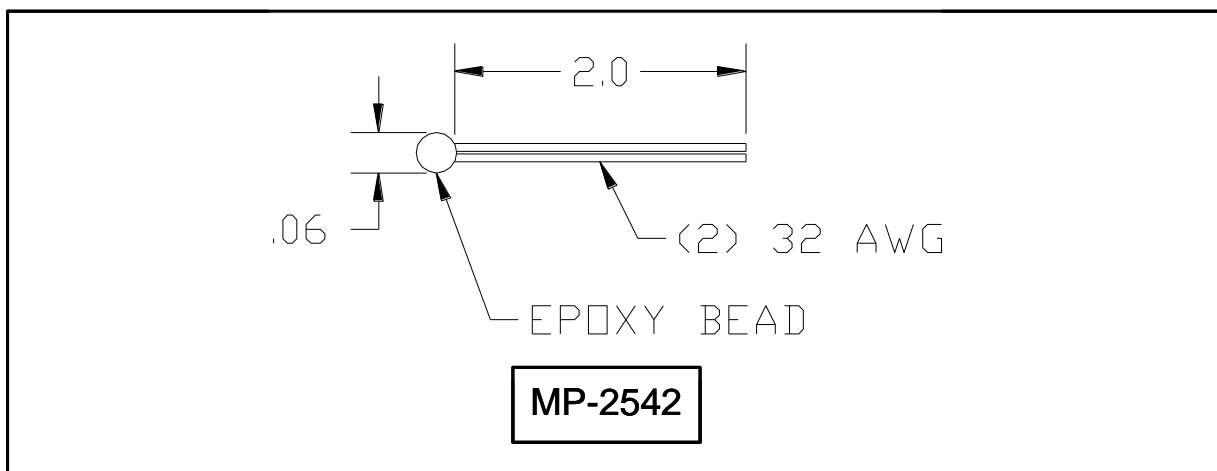
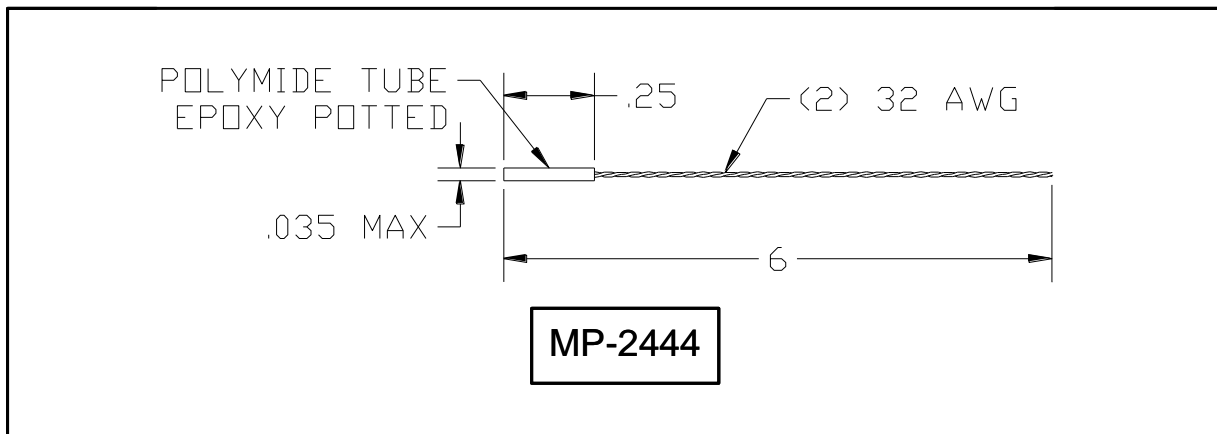
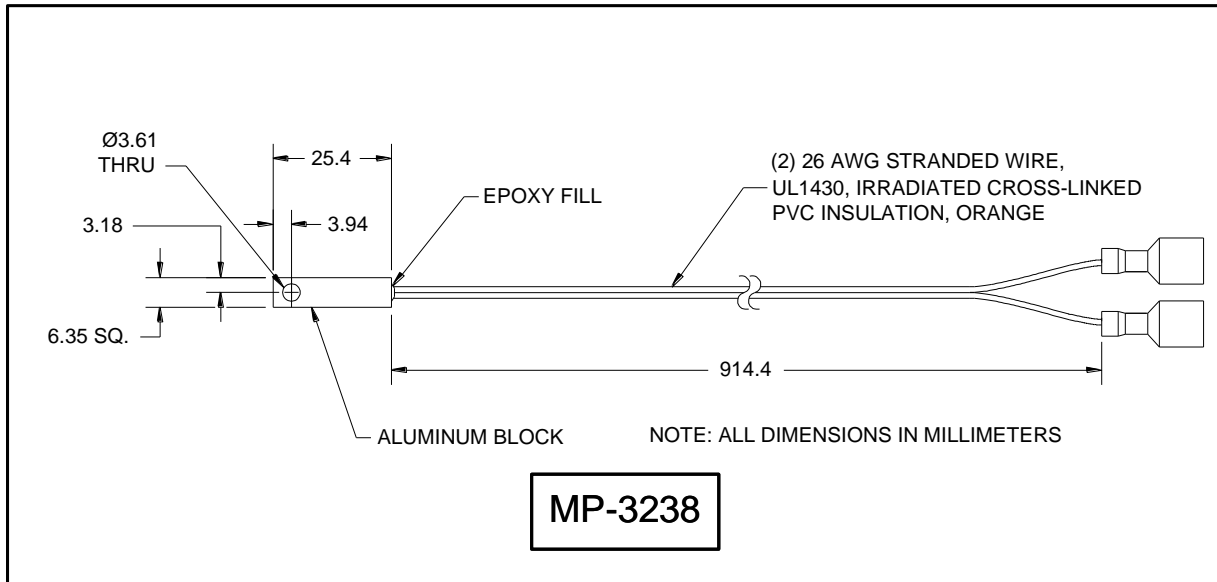

**Temperature versus Resistance
for MP-3238, MP-2444, and MP-2542 Thermistors**

-20	146735	1	46709	22	17136	43	7075	64	3227	85	1601
-19	138447	2	44397	23	16388	44	6801	65	3115	86	1551
-18	130677	3	42213	24	15676	45	6539	66	3008	87	1503
-17	123390	4	40150	25	15000	46	6289	67	2905	88	1457
-16	116554	5	38199	26	14356	47	6049	68	2806	89	1412
-15	110138	6	36354	27	13744	48	5820	69	2711	90	1369
-14	104113	7	34608	28	13161	49	5600	70	2620	91	1328
-13	98454	8	32957	29	12606	50	5391	71	2532	92	1288
-12	93137	9	31394	30	12078	51	5190	72	2448	93	1250
-11	88138	10	29914	31	11574	52	4997	73	2367	94	1212
-10	83438	11	28512	32	11095	53	4813	74	2288	95	1176
-9	79016	12	27183	33	10637	54	4637	75	2213	96	1142
-8	74855	13	25925	34	10202	55	4467	76	2141	97	1108
-7	70938	14	24731	35	9786	56	4305	77	2072	98	1076
-6	67249	15	23600	36	9389	57	4150	78	2005	99	1045
-5	63773	16	22526	37	9011	58	4001	79	1940	100	1014
-4	60498	17	21508	38	8650	59	3858	80	1878		
-3	57410	18	20541	39	8306	60	3721	81	1818		
-2	54498	19	19623	40	7976	61	3590	82	1761		
-1	51750	20	18751	41	7662	62	3464	83	1705		
0	49157	21	17923	42	7362	63	3343	84	1652		

Note: Tolerance is $\pm 650 \Omega$, corresponding to $\pm 1 \text{ }^\circ\text{C}$
over a $0 \text{ }^\circ\text{C}$ to $100 \text{ }^\circ\text{C}$ range.